



USER MANUAL

METER FOR ELECTRICAL INSTALLATION PARAMETERS

MPI-525



USER MANUAL

METER FOR ELECTRICAL INSTALLATION PARAMETERS MPI-525



**SONEL S.A.
Wokulskiego 11
58-100 Świdnica
Poland**

Version 2.10 22.06.2021

The MPI-525 meter is a modern, easy in use and safe measuring device. Please acquaint yourself with the present manual in order to avoid measuring errors and prevent possible problems related to operation of the meter.

CONTENTS

1 Safety	5
2 Menu	6
2.1 Wireless transmission	6
2.2 Settings of measurements	6
2.2.1 Network voltage and frequency	7
2.2.2 Additional results in insulation resistance measurement	7
2.2.3 Main result of short circuit loop impedance measurement	8
2.2.4 Measurement settings	8
2.2.5 Cell autoincrementing	8
2.3 Settings of the meter	9
2.3.1 LCD contrast	9
2.3.2 LCD backlight time	10
2.3.3 Auto-OFF settings	10
2.3.4 Date and time	10
2.3.5 Factory (default) settings	11
2.3.6 Program update	11
2.4 Language selection	11
2.5 Information about manufacturer	11
3 Measurements	12
3.1 Measurement of alternating voltage and frequency	12
3.2 Checking correctness of PE (protective earth) connections	12
3.3 Measurement of short circuit loop parameters	13
3.3.1 Measurement of short circuit loop parameters in L-N and L-L circuit	13
3.3.2 Measurement of short circuit loop parameters in L-PE circuit	16
3.3.3 Measurement of short circuit loop impedance in L-PE circuit protected with residual current device (RCD)	18
3.3.4 Prospective short-circuit current	19
3.4 Measurement of resistance-to-earth	20
3.5 Measurement of RCD parameters	23
3.5.1 Measurement of RCD trip current	23
3.5.2 Measurement of RCD trip time	25
3.5.3 Automatic measurement of RCD parameters	27
3.6 Measurement of insulation resistance	31
3.6.1 Double-lead measurement	31
3.6.2 Measurements with AutoISO-2500 adapter	33
3.7 Low-voltage measurement of resistance	36
3.7.1 Measurement of resistance of protective conductors and equipotential bonding with ± 200 mA current	36
3.7.2 Measurement of resistance	38
3.7.3 Calibration of test leads	39
3.8 Checking sequence of phases	41
4 Memory of measurement result data	42
4.1 Recording measurement result data in the memory	42
4.2 Viewing memory data	44
4.3 Deleting memory data	46
5 Data transmission	48
5.1 Computer connection accessories	48

5.2	Data transmission with USB.....	48
5.3	Data transmission with OR-1 radio module.....	48
6	Power supply.....	50
6.1	Monitoring of the power supply voltage.....	50
6.2	Replacement of batteries (accumulators).....	50
6.3	Charging of accumulators.....	51
6.4	General principles regarding using Ni-MH accumulators.....	52
7	Cleaning and maintenance.....	53
8	Storage.....	53
9	Dismantling and utilisation.....	53
10	Technical data.....	54
10.1	Basic data.....	54
10.2	Additional data.....	61
10.2.1	Additional uncertainties according to IEC 61557-2 (R_{ISO}).....	61
10.2.2	Additional uncertainties according to IEC 61557-3 (Z).....	61
10.2.3	Additional uncertainties according to IEC 61557-4 ($R \pm 200 \text{ mA}$).....	61
10.2.4	Additional uncertainties according to IEC 61557-5 (R_E).....	61
10.2.5	Additional uncertainties according to IEC 61557-6 (RCD).....	62
11	Accessories.....	63
11.1	Standard accessories.....	63
11.2	Optional accessories.....	64
12	Positions of the meter's cover.....	66
13	Manufacturer.....	66
14	Laboratory services.....	67

1 Safety

MPI-525 meter is designed for performing check tests of protection against electric shock in mains systems. The meter is used for making the measurements the results of which determine safety of electrical installations. Therefore, in order to provide conditions for correct operation and the correctness of the obtained results, the following recommendations must be observed:

- Before you proceed to operate the meter, acquaint yourself thoroughly with the present manual and observe the safety regulations and specifications determined by the producer.
- The MPI-525 meter has been designed for the purpose of measurements of short-circuit loop impedance, earth connection and equipotential bonding resistance, RCDs parameters as well as insulation resistance measurements. Any application that differs from those specified in the present manual may result in a damage to the device and constitute a source of danger for the user.
- The device must be operated solely by appropriately qualified personnel with relevant certificates to realise measurements of electric installation. Operation of the meter realised by unauthorised personnel may result in damage to the device and constitute a source of danger for the user.
- Using this manual does not exclude the need to comply with occupational health and safety regulations and with other relevant fire regulations required during the performance of a particular type of work. Before starting the work with the device in special environments, e.g. potentially fire-risk/explosive environment, it is necessary to consult it with the person responsible for health and safety.
- It is unacceptable to operate the following:
 - ⇒ A damaged meter which is completely or partially out of order,
 - ⇒ A meter with damaged test leads insulation,
 - ⇒ A meter stored for an excessive period of time in disadvantageous conditions (e.g. excessive humidity). If the meter has been transferred from a cool to a warm environment of a high level of relative humidity, do not realise measurements until the meter has been warmed up to the ambient temperature (approximately 30 minutes).
- It should be remembered that **BAT** message appearing on the display indicates that supply voltage of the meter is too low. This message signals also that the batteries must be replaced or the accumulator charged. Measurements performed by means of the meter whose supply voltage is too low are burdened with additional errors that are impossible to be estimated by the user. Such measurements must not be relied on in order to state correctness of protection of a network tested.
- Battery spill and damage to the meter may occur if discharged batteries are left in the meter.
- Before measurements may commence, make sure the test leads are connected to the appropriate measurement sockets.
- Do not operate a meter with an open or incorrectly closed battery (accumulator) compartment or power it from other sources than those specified in the present manual.
- The R_{SO} inputs of the meter are protected electronically from overload (e.g. due to having been connected to a live circuit) up to 440V rms for 60 seconds.
- Repairs may be realised solely by an authorised service point.

ATTENTION!

Only standard and additional accessories for a given device should be used, as listed in the "Equipment" section. Use of different accessories can lead to errors in the test connection and can introduce additional measurement uncertainties.

Attention:

Due to continuous development of the meter's software, the actual appearance of the display, in case of some of the functions, may slightly differ from the display presented in this operating manual.

Note:

An attempt to install drivers in 64-bit Windows 8 may result in displaying "Installation failed" message.

Cause: Windows 8 by default blocks drivers without a digital signature.

Solution: Disable the driver signature enforcement in Windows.

2 Menu

The Menu is accessible in each position of the rotary switch.

①



Press **MENU** push-button.

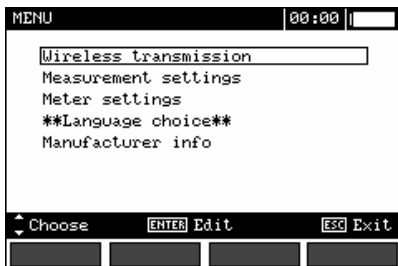

②

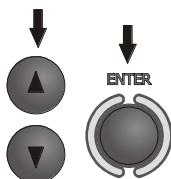

Select a proper item by means of ▲, ▼ push-buttons. Enter a selected option by pressing **ENTER**.

2.1 Wireless transmission

See chapter 5.3.

2.2 Settings of measurements

①

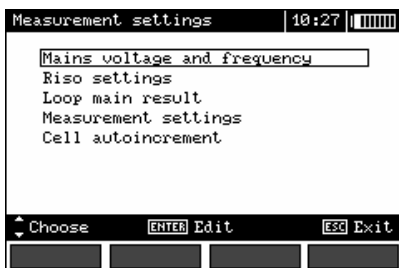

②

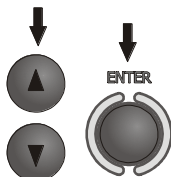

Select a proper item by means of ▲, ▼ push-buttons. Enter a selected option by pressing **ENTER**.

2.2.1 Network voltage and frequency

Before measurements a nominal network voltage U_n (110/190V, 115/200V, 127/220V, 220/380V, 230/400V or 240/415V) should be selected that is valid in the area where measurements are made. This voltage value is used for calculating the values of prospective short-circuit current.

Determination of network frequency, that is the source of potential interferences, is necessary in order to select a proper measuring signal frequency in resistance-to-earth measurements. Only the measurement conducted with a properly selected frequency of measuring signal will ensure optimum filtration of interferences. The meter is designed for filtration of interferences that originate from 50 Hz and 60 Hz networks.

①

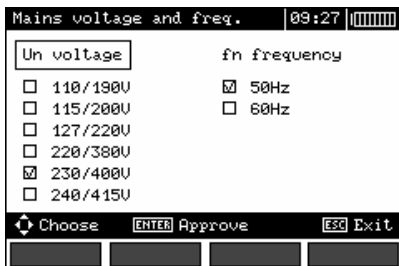

②

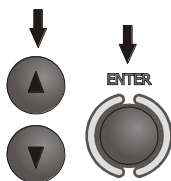

By means of ◀, ▶ push-buttons select a parameter to be changed, by means of ▲, ▼ select network voltage and frequency. Confirm a choice made by means of ENTER push-button.

2.2.2 Additional results in insulation resistance measurement

Choose the calculated absorption coefficients. The coefficients' change cause automatic setting of insulation resistance measurement time periods to the following values:

AB1, AB2 – $t_1 = 15$ s, $t_2 = 60$ s,

DAR, PI – $t_1 = 30$ s, $t_2 = 60$ s.

①



②

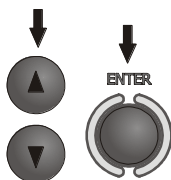

By means of ▲, ▼ select names of the additional results of insulation resistance measurement. Confirm a choice made by means of ENTER push-button.

2.2.3 Main result of short circuit loop impedance measurement

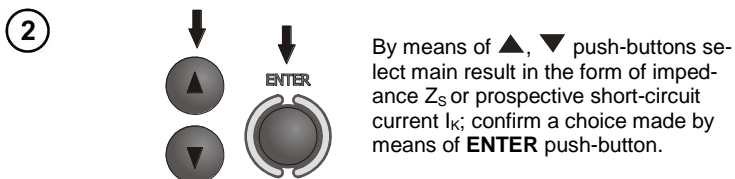
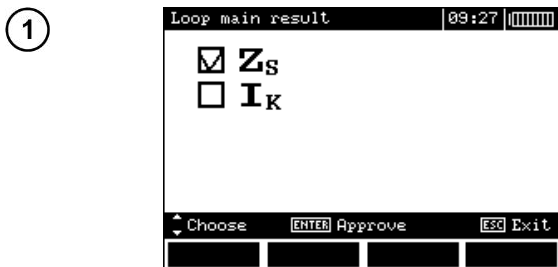

2.2.4 Measurement settings

The setting enables activation/deactivation of the field displaying measurement settings. Show or hide the field with measurement settings by means of ▲ and ▼ push-buttons, press ENTER push-button.

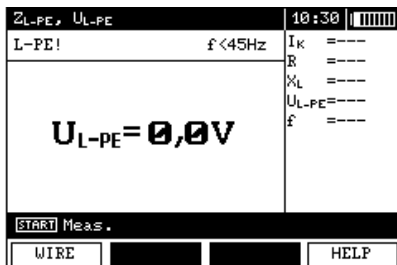
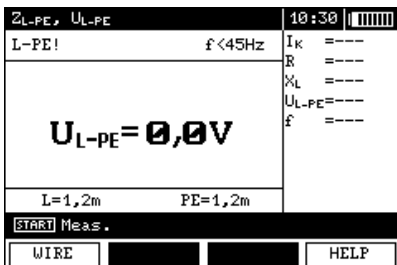

2.2.5 Cell autoincrementing

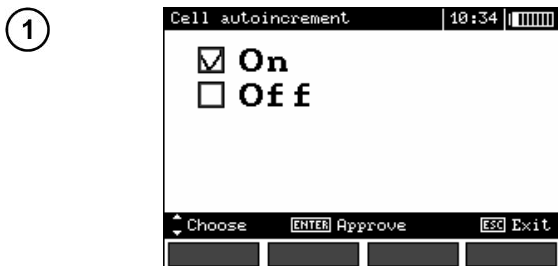

2

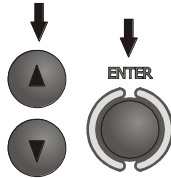

By means of ▲, ▼ push-buttons select the option of automatic incrementing of field number after its storing in the memory or the manual incrementing option (automatic incrementing is deactivated); confirm a choice made by means of **ENTER** push-button.

2.3 Settings of the meter

1

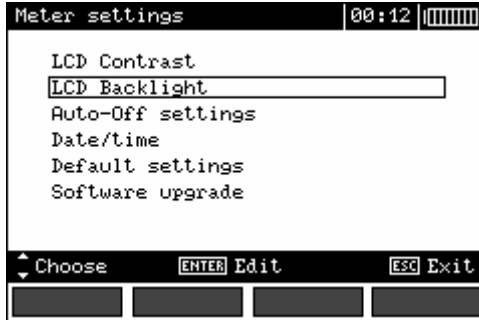

2

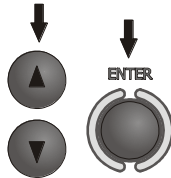

Select a suitable item by means of ▲, ▼ push-buttons; enter the edition of a selected option by means of **ENTER** push-button.

2.3.1 LCD contrast

1

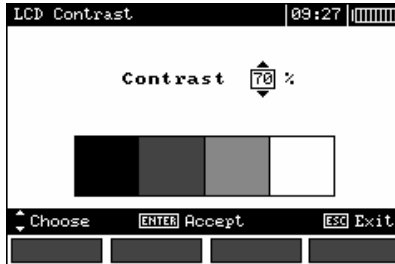

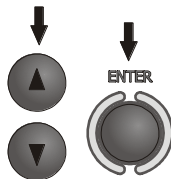

2



Select contrast value by means of ▲, ▼ push-buttons; confirm a choice made by means of **ENTER** push-button.

2.3.2 LCD backlight time

User can turn the LCD backlight on at any time by pushing  button. The LCD backlight setting defines the period, after which the backlight is automatically turned off. When “Always” option is chosen, to turn the backlight off user will need to push  button again.

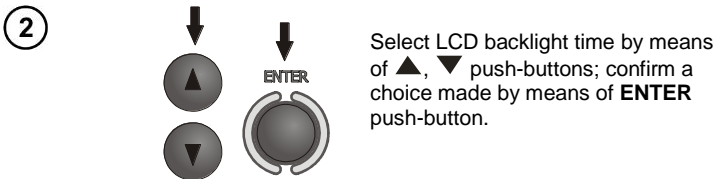
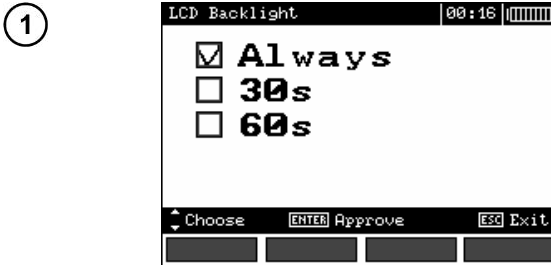

2.3.3 Auto-OFF settings

The setting defines time till automatic shutdown of idle meter.

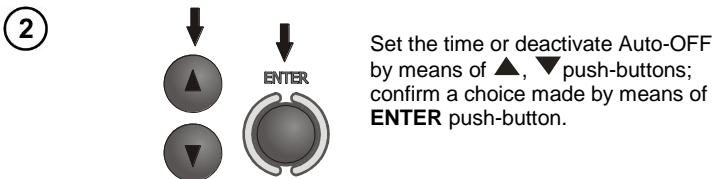

2.3.4 Date and time

By means of ◀, ▶ push-buttons select the value to be changed (day, month, year, hour, minute). Set a required value by means of ▲, ▼ push-buttons. When required settings are made, press ENTER push-button.

2.3.5 Factory (default) settings

In order to introduce factory (default) settings, highlight **YES** by means of ◀, ▶ push-buttons and press **ENTER** push-button.

2.3.6 Program update

ATTENTION!

This function may be used only by the users who are fluent in operation of computer equipment.
The guarantee does not cover defective operation of the device resulting from wrong use of this function.

ATTENTION!

A new package of batteries should be installed before programming or the accumulator should be charged.
During programming the meter must not be switched off as well as the transmission cable must not be disconnected.

Before updating the program, download the program that is use for programming the meter from the manufacturer's website (www.sonel.pl), install this program on your computer and connect the meter to the computer.

Select **Software upgrade** in the MENU and follow the instructions displayed by the program.

2.4 Language selection

- By means of ▲ and ▼ push-buttons choose ****Language choice**** in the main MENU; press **ENTER** push-button.
- Select a required language by means of ▲ and ▼ push-buttons; press **ENTER** push-button.

2.5 Information about manufacturer

By means of ▲ and ▼ push-buttons choose **Manufacturer info** in the main MENU; press **ENTER** push-button.

3 Measurements

Remarks:

- A progress bar is displayed during long measurements.
- The content of this chapter should be thoroughly familiarized with since it describes the meter circuits, the methods of measurements and basic principles concerning interpretation of measurement results.
- Result of the latest measurement is remembered by the meter until a next measurement is started or measurement settings are changed or the measuring function is changed by means of the rotary switch or the meter is switched off. The result of the latest measurement is displayed on the screen for 20 seconds. It can be recalled by pressing **ENTER** push-button.

WARNING:

During measurements (short circuit loop, RCD), earthed parts and parts accessible in the electrical installation being tested must not be touched.

WARNING:

During a measurement, switching of the range switch is forbidden because it may damage the meter and pose a threat to the user.

3.1 Measurement of alternating voltage and frequency

The meter measures and displays alternating voltage and frequency of the network in all measuring functions except R_E , R_X , $R_{\pm 200mA}$, $R_{ISO-conductor}$. For Ⓢ and R_{ISO} functions, only voltage is displayed. This voltage is measured for the frequencies within the range of 45..65 Hz as True RMS. If a frequency measured is outside the specified range, a proper message is displayed instead of the frequency value: $f < 45 \text{ Hz}$ or $f > 65 \text{ Hz}$. Voltage is displayed as the main result only for $U_{L-N,L-L}$, $Z_{L-N,L-L}$, U_{L-PE} , Z_{L-PE} and U_{L-PE} Z_{L-PE} **RCD**. The test leads should be connected as for a given measuring function.

3.2 Checking correctness of PE (protective earth) connections

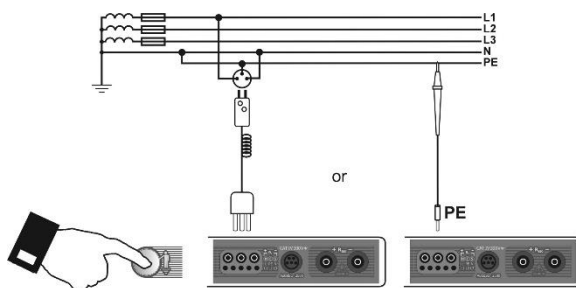

When the meter is connected according to the drawing, touch the touch electrode with a finger and wait for about 1 second. When voltage is found on PE, the device displays **PE!** message (error in the installation; PE lead is connected to the phase lead) and generates a continuous audio signal. This possibility is available for all measuring functions that apply to residual current devices (RCD) and short circuit loop.

3

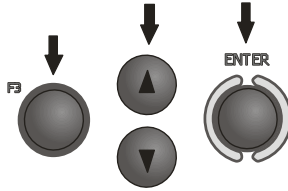

In order to select the voltage for calculating the prospective short circuit current I_k - nominal or measured - press **F2**

I_k

Use ▲, ▼ to select desired voltage and press **ENTER**.

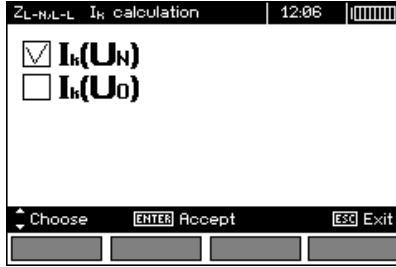

4

Connect test leads according to the drawing
 a) for measurement in L-N circuit or
 b) for measurement in L-L circuit

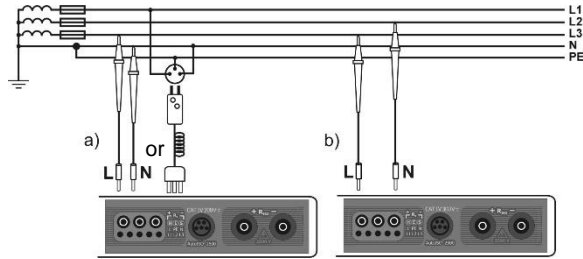

5

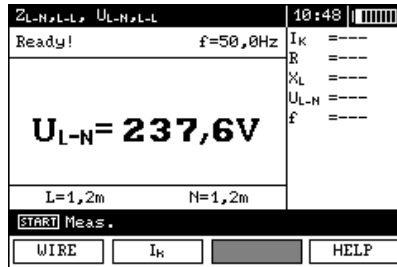

The meter is ready for measurement.

6

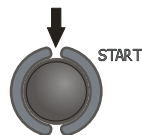

Make measurement by pressing **START** push-button

7

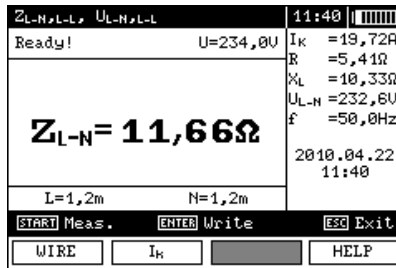



Read out the result.

The result is displayed on the screen for 20s.
The result can be recalled by pressing **ENTER** push-button.

Remarks:

- The result can be stored in the memory (see point 4.1).
- When many measurements are made in short time intervals, the meter may emit a large amount of heat. As a result of this, the housing of the device may become hot. This is a normal phenomenon and the meter is equipped with the protection against excessive temperature. After approximately 15 consecutive measurements of short circuit loop, wait until the instrument cools down. This limitation results from the high current measurement and multi-functionality of the meter.
- Minimum interval between successive measurements is 5 seconds. This minimum interval requirement is controlled by the meter. A next measurement can be made only when **READY!** message appears on the screen.

Additional information displayed by the meter

READY!	The meter is ready for measurement.
L-N!	U_{L-N} voltage is incorrect for making a measurement.
L-PE!	U_{L-PE} voltage is incorrect for making a measurement.
N-PE!	U_{N-PE} voltage exceeds allowable value of 50V.
	Phase connected to N terminal instead of L terminal (for example, exchange of L and N in the mains socket).
	Temperature exceeded.
f!	Network frequency is outside the range of 45...65 Hz.
Error during measurement	A correct result can not be displayed.
Loop circuit malfunction!	The meter should be serviced.
No U_{L-N}!	Lack of U_{L-N} voltage before the principal measurement.
U>500 V! and continuous audio signal	Before measurement, voltage at test terminals exceeds 500 V.

3.3.2 Measurement of short circuit loop parameters in L-PE circuit

1

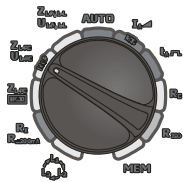

Set the rotary switch of function selection at Z_{L-PE}/U_{L-PE} position.

2

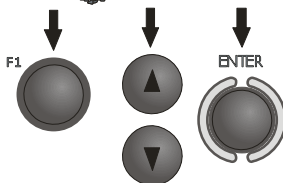

Press **F1** push-button if L lead length needs to be selected. Select a lead length by means of **▲** and **▼** push-buttons and press **ENTER** push-button.

3

Connect test leads according to one of the drawings.

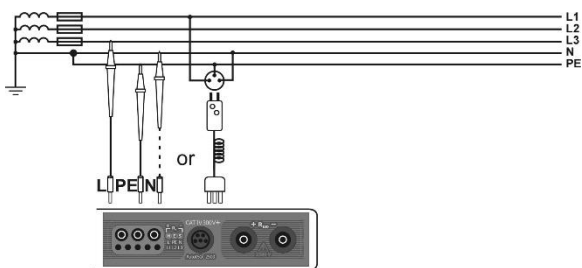

Checking effectiveness of protection against electric shock of the device housing in case of: a) TN network b) TT network

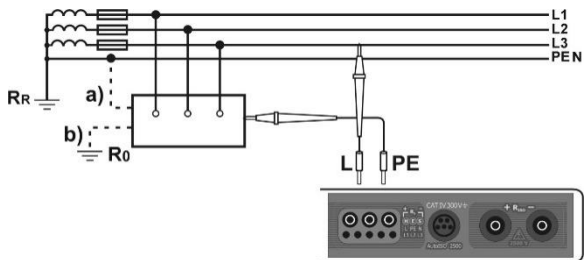

4

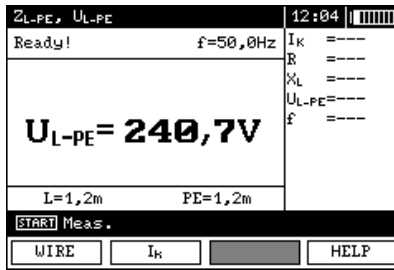

The meter is ready for measurement.

5



START

Make measurement by pressing **START** push-button.

6

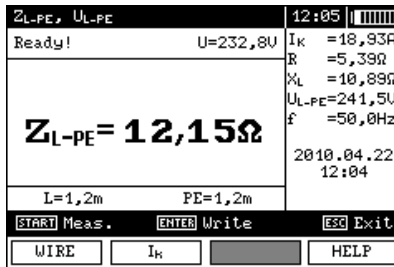

Read out the result.

The result is displayed on the screen for 20s.

The result can be recalled by pressing **ENTER** push-button.

Remarks:

- Double lead measurement is possible when a test lead other than the lead with a mains socket is selected.
- Remaining issues connected with the measurements as well as the messages displayed are the same as those described for measurements in L-N circuit or L-L circuit.

3.4 Measurement of resistance-to-earth

The three-pole measuring method is the basic type of resistance-to-earth measurement.

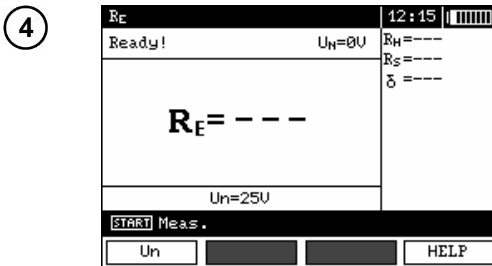
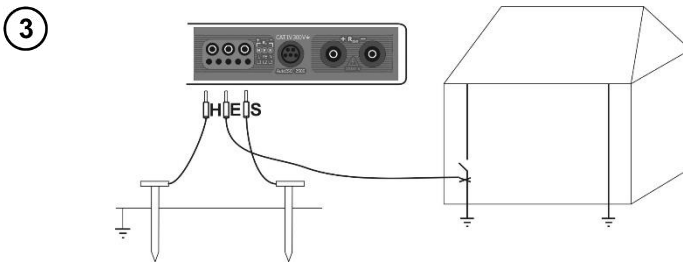
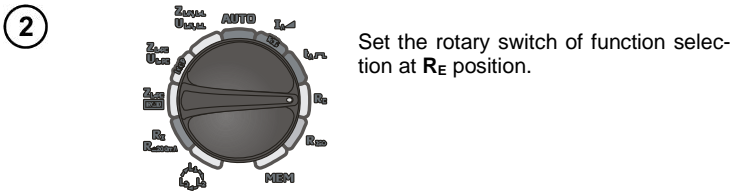
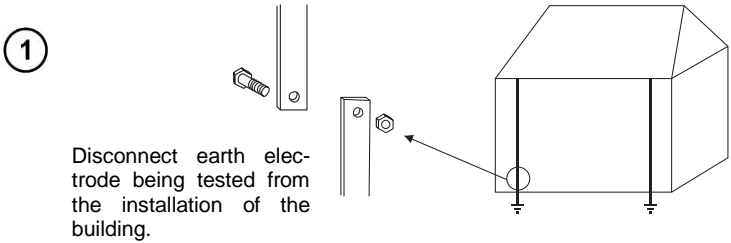

The meter is ready for measurement. Value of interference voltage U_N can be read on the display.

5

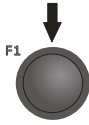

Press F1 push-button to change test voltage.

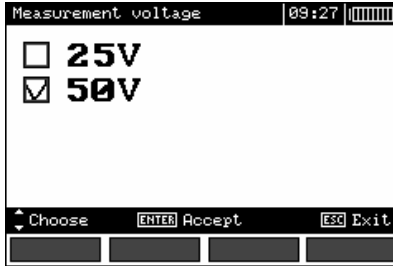

6

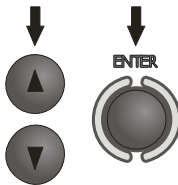

Select test voltage by means of push-buttons and confirm by pressing ENTER.

7

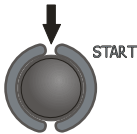

Press START push-button to start the measurement.

8

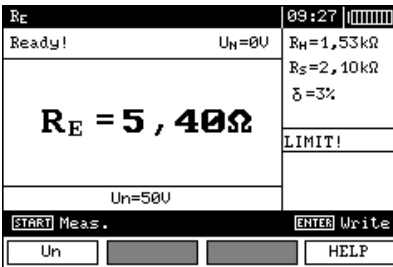

Read out the result.

Resistance of current electrode

Resistance of voltage electrode

Value of additional uncertainty caused by resistance of the electrodes

9

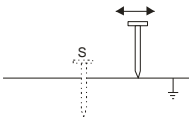

Repeat the measurements (points 3, 7, 8) shifting the voltage electrode several metres: the electrode should be shifted farther and closer to the earth electrode being tested. If R_E measurement results differ from one another by more than 3%, the distance of the current electrode from the earth electrode being tested should be considerably increased and the measurements should be repeated.

Remarks:



Measurement of resistance-to-earth may be carried out if voltage of interferences does not exceed 24 V. Voltage of interferences is measured up to the level of 100 V but above 50 V it is signalled as dangerous. The meter must not be connected to voltages exceeding 100 V.

- Particular attention should be paid to quality of connection between the object being tested and the test lead – the contact area must be free from paint, rust, etc.
- If resistance of test probes is too high, R_E earth electrode measurement will be burdened with additional uncertainty. Particularly high uncertainty of measurement occurs when a small value of resistance-to-earth is measured with probes that have a weak contact with earth (such a situation occurs frequently when the earth electrode is well made and the upper soil layer is dry and slightly conductive). In such a case, the ratio between resistance of the probes and resistance of the earth electrode tested is very high and consequently, uncertainty of measurement that depends on this ratio is also very high. The uncertainty is displayed on the screen in the column of additional results. In order to reduce the uncertainty, it is recommended to improve the contact between the probe and soil, for example, by dampening with water the place where the probe is driven into earth, driving the probe into earth in a different place or using a 80 cm-long probe. Test leads should also be checked as follows: check whether their insulation is not defective and whether the lead – banana plug – probe contact areas are not corroded or loosened. In majority of cases the measurement accuracy achieved is satisfactory. However, one should always be aware of uncertainty value the measurement is burdened with.

Additional information displayed by the meter

$R_E > 1,99 \text{ k}\Omega$	Measuring range is exceeded.
$U_N!$	Voltage at test terminals is higher than 24 V but lower than 50 V, measurement is blocked.
$U_N > 50 \text{ V}!$ and continuous audio signal	Voltage at test terminals is higher than 50 V.
NOISE!	Too low value of signal/noise ratio.
LIMIT!	Error caused by resistance of electrodes > 30%. (Measured values are used in calculation of uncertainty.)
	Interruption in measuring circuit or resistance of test probes is higher than 60 k Ω .
Electrode resistance > 50 kΩ	Resistance of electrodes within the range of 50...60 k Ω .
Aborted!	Measurement has been interrupted with ESC key button.

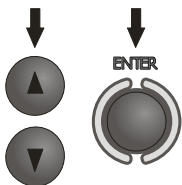

Select an appropriate item by means of ▲ and ▼ push-buttons and confirm by pressing ENTER.

5

Connect the device to the installation according to the drawing.

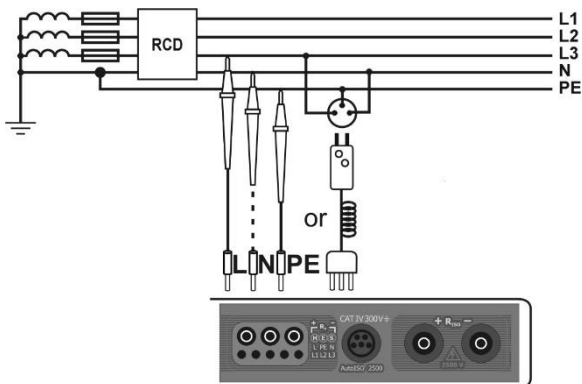

6

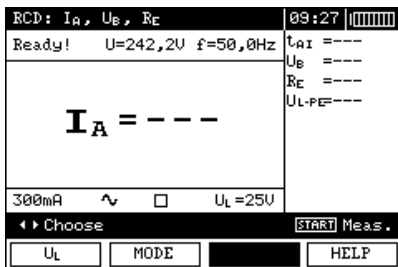

The meter is ready for measurement. Value of network voltage and frequency can be read on the display.

7

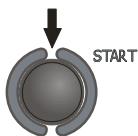

Press **START** to begin measurement.

8

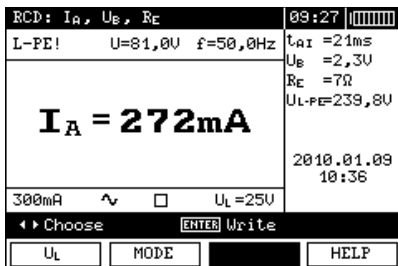

Read out the result.

Remarks:

- Measurement of t_{AI} trip time for selective RCD is not available.

Additional information displayed by the meter

$U_B > U_L!$	Touch voltage U_B exceeds a preset U_L threshold value.
!	! placed on the right side of the result means that RCD is out of order
No $U_{L-N}!$	Lack of neutral lead that is necessary for $I_{\Delta n}$ constant and pulsed with direct current offset

The remaining information is the same as for fault loop measurement (first 7 positions under point 3.4.1).

3.5.2 Measurement of RCD trip time

1

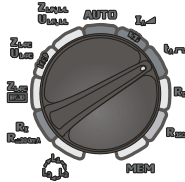

Set the rotary switch of function selection at t_{A} position.

2

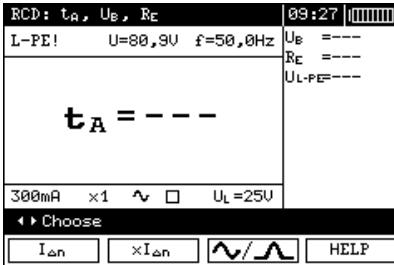

Press **F1** $I_{\Delta n}$ push-button and move to selection of $I_{\Delta n}$.

Press **F2** $xI_{\Delta n}$ push-button and move to selection of $I_{\Delta n}$ multiplication factor

Press **F3** Δ push-button and move to selection of current waveform.

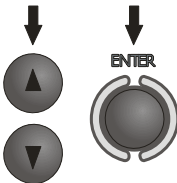

Select an appropriate item by means of \blacktriangle and \blacktriangledown push-buttons and confirm by pressing **ENTER**.

3



Move to selection of a second group of parameters by means of \blacktriangleleft and \blacktriangleright push-buttons.

4

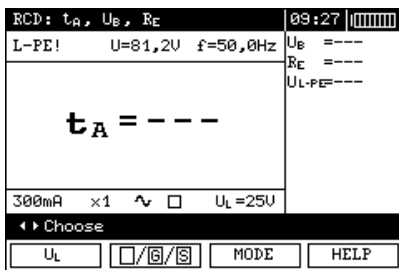

Press **F1** U_L push-button and move to selection of U_L .

Press **F2** $[U/G/S]$ push-button and move to selection of RCD type.

Press **F3** **MODE** push-button and move to selection of measurement mode.

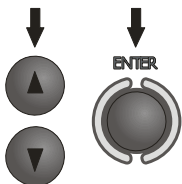

Mark an appropriate position by means of \blacktriangle and \blacktriangledown push-buttons and confirm by pressing **ENTER**.

5

Connect the device to the installation according to the drawing.

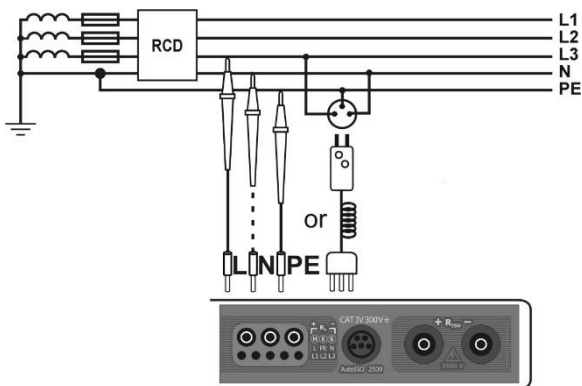

6

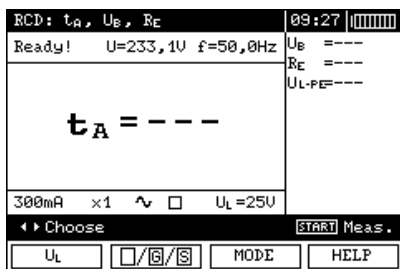

The meter is ready for measurement. Value of network voltage and frequency can be read on the display.

7

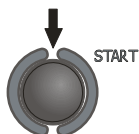

Press **START** to begin measurement.

8

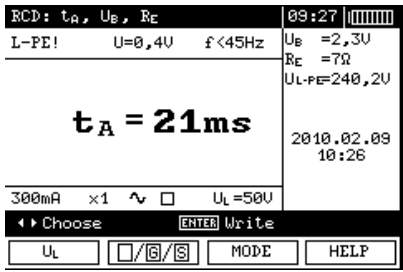

Read out the result.

Remarks and information are the same as for I_A measurement.

3.5.3 Automatic measurement of RCD parameters

The meter enables automatic measurement of the following: RCD trip times (t_A), trip current (I_A), touch voltage (U_B) and resistance-to-earth (R_E). Additionally, there is a possibility of automatic measurement of short circuit loop impedance Z_{L-PE} **RCD** in a manner described in point 3.4.3. In the automatic mode, it is not necessary to actuate a measurement each time by means of **START** push-button. The operator of the meter only has to initiate a measurement by pressing **START** push-button once and switch RCD on each time after it is tripped. The below table shows maximum number of parameters measured and sequence of measurements for preset value of rated current $I_{\Delta n}$, selected current waveform, type of RCD (standard / selective / short-time delay) and U_L voltage.

No.	Parameters measured	Measurement conditions	
		$I_{\Delta n}$ multiplication factor	Initial phase (polarization)
1.	Z_{L-PE}		
2.	U_B, R_E		
3.	t_A	$0,5I_{\Delta n}$	positive
4.	t_A	$0,5I_{\Delta n}$	negative
5.*	t_A	$1I_{\Delta n}$	positive
6.*	t_A	$1I_{\Delta n}$	negative
7.*	t_A	$2I_{\Delta n}$	positive
8.*	t_A	$2I_{\Delta n}$	negative
9.*	t_A	$5I_{\Delta n}$	positive
10.*	t_A	$5I_{\Delta n}$	negative
11.*	I_A		positive
12.*	I_A		negative

* points in which an efficient RCD should disconnected

5

Connect the device to the installation according to the drawing.

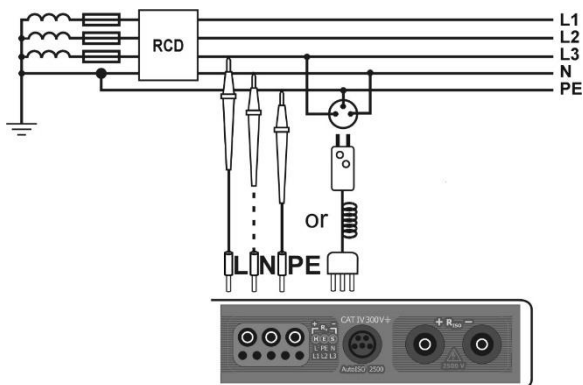

6

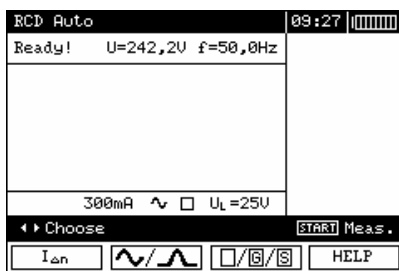

The meter is ready for measurement. Value of network voltage and frequency can be read on the display.

7

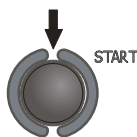

Press **START** push-button to start the measurement. If such measurements are selected that require triggering of RCD, operator of the meter should be in the vicinity of RCD and switch it on each time after it is tripped until the measurements are completed (a longer interruption may signify completion of the measurements).

8

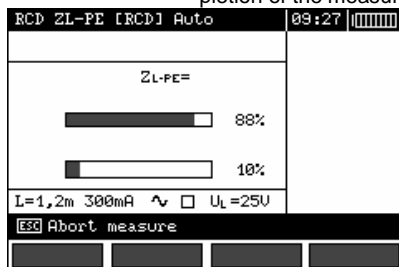

Progress of measurement process is shown by progress bars: lower bar – total cycle; upper bar – measurement of Z_{L-PE} RCD and I_A .

9

RCD ZL-PE [RCD] Auto		09:27	
Z_{L-PE} = 11,84Ω		I _k = 19,42A	
		R = 6,15Ω	
		X _L = 10,12Ω	
		U _{L-PE} = 242,6V	
		f < 45Hz	
		2010.02.09	
		10:26	
L=1,2m 300mA ~ □ U _L =50U		1/2	
[ENTER] Write		[ESC] Exit	
		[Screen] [Screen]	

Read out the result.

10

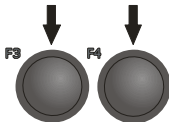

Groups of results displayed are changed by means of F3 and F4 push-buttons.

RCD ZL-PE [RCD] Auto		09:27	
		GOOD	
I _A	=272mA+ =272mA-	U _B	=1,2U
t _A (0.5I)	>300ms+ >300ms-	R _E	=4Ω
t _A (1I)	=39ms+ =29ms-	U _{L-PE}	=240,5U
t _A (2I)	=19ms+ =10ms-	2010.02.09	
t _A (5I)	=0ms+ =0ms-	10:26	
L=1,2m 300mA ~ □ U _L =50U		1/2	
[ENTER] Write		[ESC] Exit	
		[Screen] [Screen]	

Remarks:

- The measurement is interrupted, if during measurement of U_B/R_E, RCD has been tripped at 0.5I_{An} current or if RCD has not been tripped in other cases or if a preset value of safe voltage U_L has been exceeded.
- Store the result in the memory (see point 4.1) or press **ESC** push-button and display only network voltage and frequency.
- Remaining remarks and information are the same as for I_A and Z_{L-PE} measurement.

3.6 Measurement of insulation resistance

WARNING:
 The object tested must not be live.
 Presence of any voltage across tested object is prohibited.

3.6.1 Double-lead measurement

1

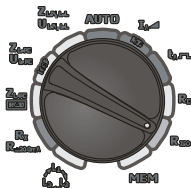

Set the rotary switch of function selection at **Riso** position.

2

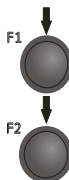
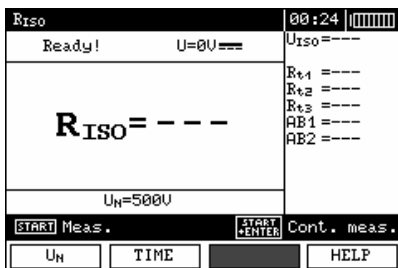

Press **F1** **U_N** push-button and move to selection of nominal test voltage U_N .

Press **F2** **TIME** push-button and move to selection of t_1 , t_2 and t_3 periods. The “---” value means that the period counting is disabled.

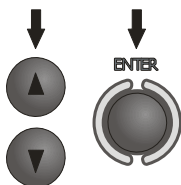

Select an appropriate item by means of ▲ and ▼ push-buttons and confirm by pressing **ENTER**.

3



Change the calculated absorption coefficients, if needed (point 2.2.2). Make sure that t_1 , t_2 and t_3 periods have the proper values.

4

Connect test leads according to the drawing.

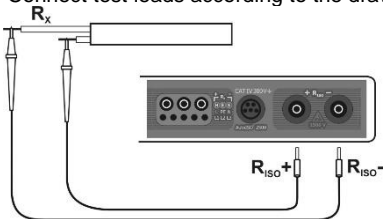

5

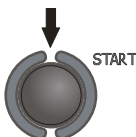

Press and hold **START** push-button.

Measurement is performed continuously when the push-button is held in the pressed position.

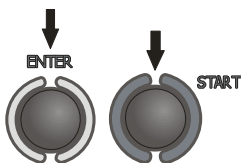

In order to maintain the measurement, press **ENTER** push-button while holding **START** push-button in the pressed position. In order to interrupt the measurement, press **START** push-button again.

6

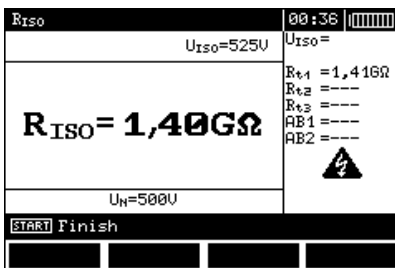

View of the screen during measurement performed with the use of **ENTER** push-button.

At the end of the particular time period the current value of the insulation resistance (designated as R_{t1} , R_{t2} or R_{t3} according to the time period that has expired) is displayed. Absorption coefficients are calculated as:

$Ab1 = DAR = R_{t2} / R_{t1}$ and $Ab2 = PI = R_{t3} / R_{t2}$.

7

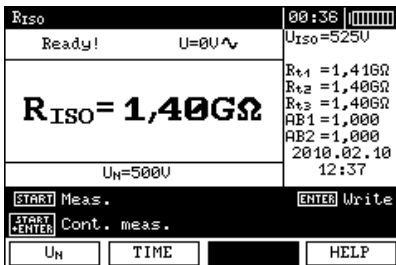

Read out the result.

3

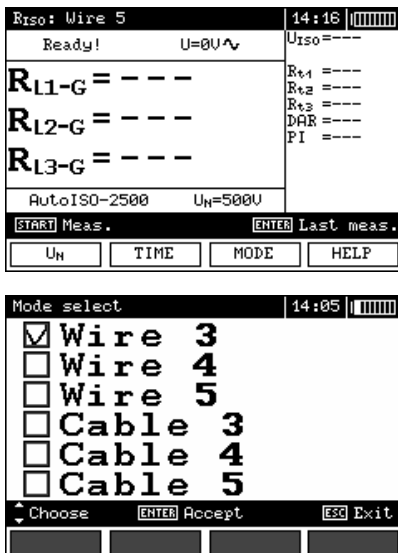

Press **F1** **U_N** push-button and move to selection of nominal test voltage U_N .

Press **F2** **TIME** push-button and move to selection of a single measurement time.

Press **F3** **MODE** push-button and move to selection of lead or energetic cable type (3-, 4- or 5-cores lead).

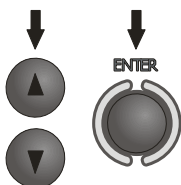

Select an appropriate item by means of ▲ and ▼ push-buttons and confirm by pressing **ENTER**.

4

Connect AutoISO-2500 adapter to the lead tested.

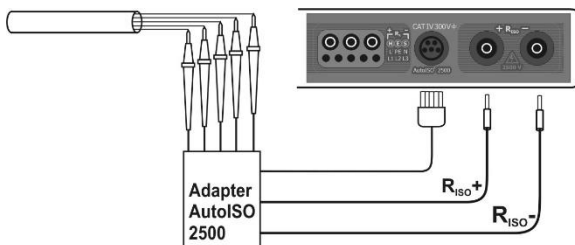

5

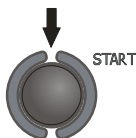

Press **START** push-buttons to start measurement. First, checking of voltages on particular pairs of cores is performed.

If any of the voltages exceeds allowable voltage, the symbol of this voltage with "!" mark is displayed (e.g. $U_{N-PE}!$) and the measurement is aborted.

6

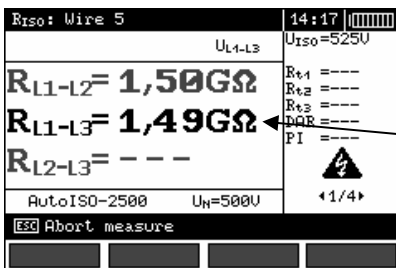

View of the screen during measurement.

Result of the present measurement is displayed in black.

7

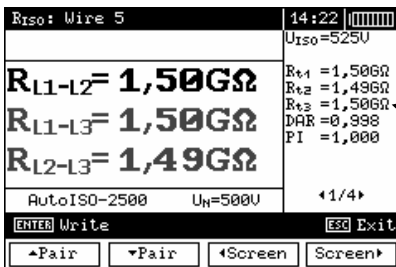

Read out the results.

Additional results regarding to selected pair of cores (which main result is displayed in black)

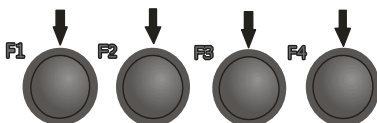

Selected pair of cores is changed by means of F1 and F2 push-buttons.

Groups of results displayed are changed by means of F3 and F4 push-buttons.

Remarks:

- The difference between the measuring of leads and energetic cables is as follows: for the leads the insulation between all the pairs of cores is measured, for energetic cables – between each of cores and the others connected to each other and to the ground.
- During the measurement of energetic cables the lead of AutoISO 2500 marked \perp must be connected to the ground.
- Other remarks and messages the same as in point 3.6.1.

3.7 Low-voltage measurement of resistance

3.7.1 Measurement of resistance of protective conductors and equipotential bonding with ± 200 mA current

1

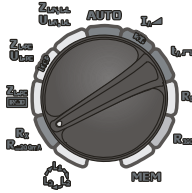

Set the rotary switch of function selection at R_X $R_{\pm 200}$ mA position.

2

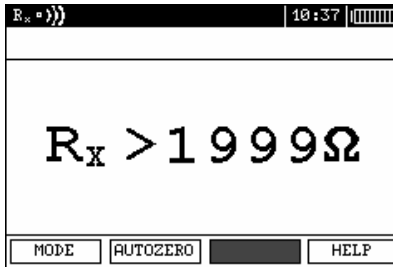

Press F1 push-button and move to selection of measurement mode.

3

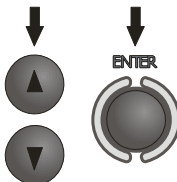

Select R_{CONT} ± 200 mA item by means of \blacktriangle and \blacktriangledown push-buttons and confirm by pressing ENTER.

4

Connect the meter to the object tested.
Measurement starts automatically.

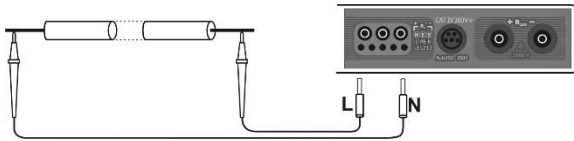

5

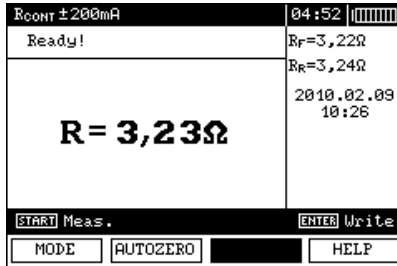

Read out the results.

6

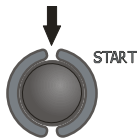

Press **START** push-button in order to start a next measurement without disconnecting test leads from the object.

Remarks:

ATTENTION!

When “Object under voltage” message is displayed, the object tested is live. The measurement is blocked. The meter must be immediately disconnected from the object.

Additional information displayed by the meter

NOISE!	Interference voltage occurs on the object tested. The measurement is possible however it will be burdened with additional uncertainty that is specified in the technical data.
---------------	--

3.7.2 Measurement of resistance

①

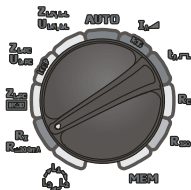

Set the rotary switch of function selection at $R_X R_{\pm 200 mA}$ position.

②

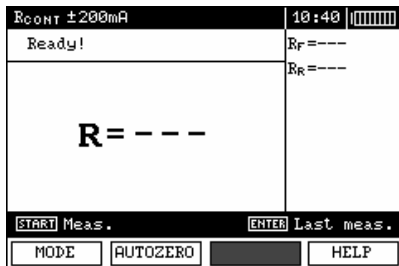

Press F1 push-button and move to selection of measurement mode.

③

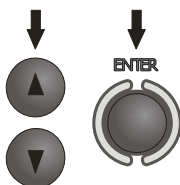
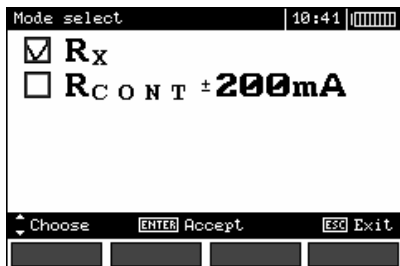

Select R_X position by means of \blacktriangle and \blacktriangledown push-buttons and confirm by pressing ENTER.

④

Connect the meter to the object tested.

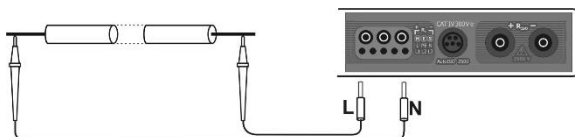

5

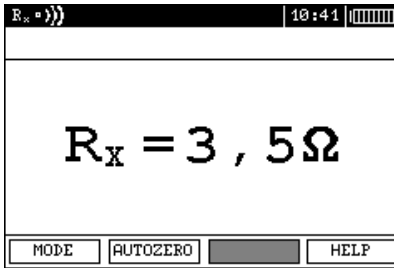

Read out the result.

Remarks:

- Remarks and messages are the same as in point 3.8.1.

3.7.3 Calibration of test leads

To eliminate the influence of the resistance of test leads on measurement result, the compensation (autozeroing) of resistance should be performed. For this purpose, R_X and $R_{\pm 200\text{ mA}}$ functions have **AUTOZERO** sub-function.

1

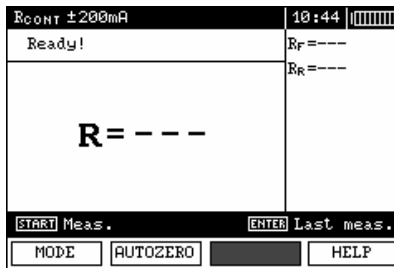

2



Press F2 push-button.

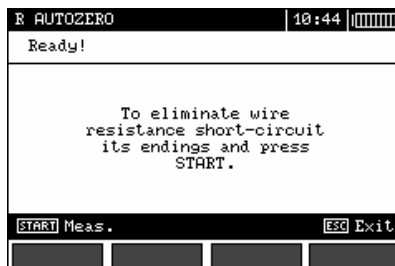

3

Follow the instructions displayed on the screen.

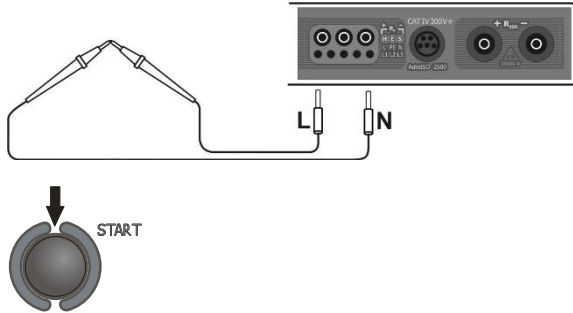

4

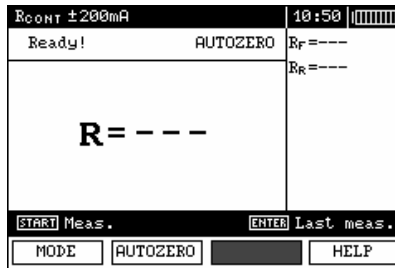

AUTOZERO message appears that confirms completion of test leads calibration.

5

To remove the AUTOZERO compensation (return to default calibration), perform the above-mentioned activities, but with test leads open in point 3.

3.8 Checking sequence of phases

1

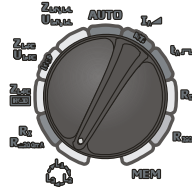

Set the rotary switch of function selection at $L_1 L_2 L_3$ position.

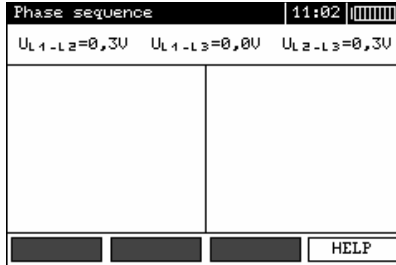

2

Connect the meter to the installation according to the drawing.

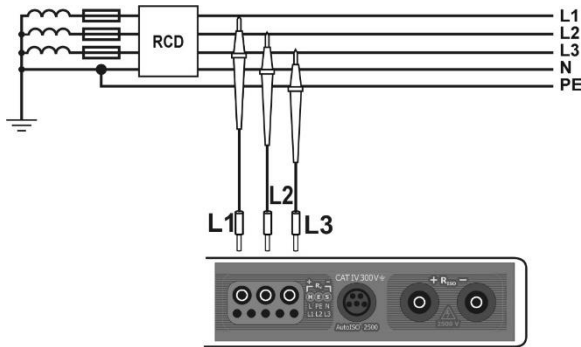

The arrow rotates clockwise: correct sequence of phases; the arrow rotates counterclockwise: incorrect sequence of phases.

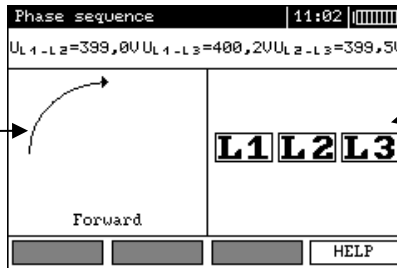

Phase-to-phase voltages.

Signalling the presence of individual phases.

4 Memory of measurement result data

MPI-525 meters are equipped with the memory that can store 50,000 single measurement results. The whole memory is divided into 10 memory banks containing 99 memory cells each. Thanks to dynamic memory allocation, each of the memory cells can contain different quantity of single measurement results, depending on the needs. Optimal use of the memory can be ensured in this way. Each measurement result can be stored in a memory cell marked with a selected number and in a selected memory bank. Thanks to this, the user can, at his/her option, assign memory cell numbers to individual measurement points and the memory bank numbers to individual objects as well as the user can perform measurements in any sequence and repeat them without losing other data.

Memory of measurement result data **is not deleted** when the meter is switched off. Thanks to this, the data can be later read or sent to a computer. Also, the number of a current memory cell or memory bank is not changed.

Remarks:

- Results of measurements performed for all measuring functions can be stored in one memory cell.
- When autoincrementing of memory cell number is deactivated, a single result (group of results) stored into the memory does not increase automatically the number of the current memory cell in order to enable storing in this memory cell successive measurement results concerning a given measurement point (object). If series of measurements are made for one function, autoincrementing of memory cell number can be set in MENU. Such autoincrementing takes place after each case of data storing in the memory (activation of autoincrementing – point 2.1.5).
- Only the results of the measurements started by pressing **START** key button can be stored in the memory (except autozeroing in low-voltage measurement of resistance).
- Deletion of the memory is recommended after reading the data or before performing a new series of measurements that may be stored into the same memory cells as the previous ones.

4.1 Recording measurement result data in the memory

1



Press **ENTER** after completion of measurement.

Type of measurement result to be stored →

The frame indicates that at least one result is stored in the cell.

The frame indicates at least one cell in the bank has measurement results stored in it.

The cell is free for a given type of measurement.

There are 6 results or one result consisting of 6 screens in the cell.

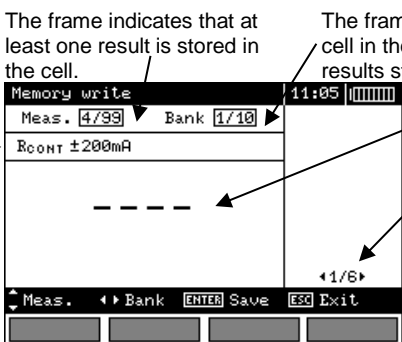

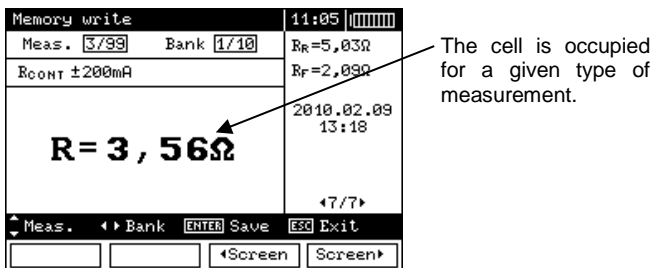

- ② Measurement (memory cell) is selected by means of ▲ and ▼ push-buttons; memory bank is selected by means of ◀ and ▶ push-buttons. Storing of data in the memory is performed by means of **ENTER** push-button.
- ③ If you try to store data in an occupied memory cell, the following warning message will appear:

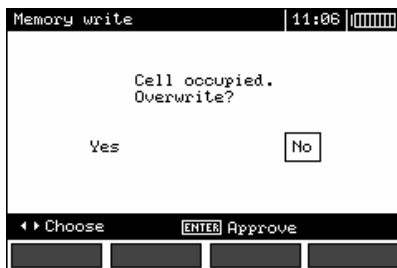

- ④ After selection of an option by means of ◀ and ▶ push-buttons, press **ENTER** push-button.

Remarks:

- In case of RCD the above warning message will appear also when an attempt is made to store a result of specific measurement (or result component) that has been made at different preset I_{AN} current or for a different preset type of RCD (standard / short-time delay / selective) than the measurements the results of which are already stored in this cell, despite the fact that the memory space designated for this result component may be free. When results of measurements made for a different type of RCD or a different I_{AN} current are stored, the results concerning a given RCD that have been stored previously will be lost.
- Complete set of results (main result and supplementary results) for a given measuring function and preset measurement settings are stored in the memory.

4.2 Viewing memory data

①

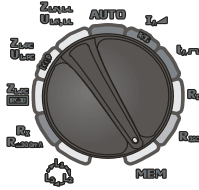

Set the rotary switch of function selection at **MEM** position.

②



Select “**Memory browsing**” by means of ▲ and ▼ push-buttons.



③



Press **ENTER** push-button.

Memory browsing		08:20	
Meas. 1/1	Bank 1/1	$I_k = 17,80A$	
ZL-PE, UL-PE		$R = 9,19\Omega$	
ZL-PE = 12,92Ω		$X_L = 9,08\Omega$	
		$UL-PE = 241,3U$	
		$f = 50,0Hz$	
		2018.02.09	
		10:26	
		◀1/4▶	
Meas.	◀▶ Bank	[ESC] Exit	
		◀Screen Screen▶	

First of the four results stored in this cell.

④

Select memory bank by means of ◀ and ▶ push-buttons; select a memory cell by means of ▲ and ▼ push-buttons; particular results or components of the result are selected by means of F3 and F4 push-buttons.

The following table specifies the sequence of data storing for individual measurement results.

No.	Main result	Supplementary results
1	Z_{L-PE} [RCD] or I_K	I_K or Z_{L-PE} [RCD]
		R
		X_L
		U_{L-PE}
		f
2	t_A at $0.5I_{\Delta n}$, sinusoidal current, positive and negative initial phase	U_B
		R_E
		U_{L-N}
3	t_A at $1I_{\Delta n}$, sinusoidal current, positive and negative initial phase t_A at $2I_{\Delta n}$, sinusoidal current, positive and negative initial phase t_A at $5I_{\Delta n}$, sinusoidal current, positive and negative initial phase	
4	I_A , sinusoidal current, positive and negative initial phase	
5-7	as above for unidirectional pulsed current and positive and negative polarization	
8-10	as above for unidirectional pulsed current with direct current offset and positive and negative polarization	
11-13	as above for direct current and positive and negative polarization	
14	Z_{L-N} (Z_{L-L}) or I_K	I_K or Z_{L-N} (Z_{L-L})
		R
		X_L
		U_{L-N} (U_{L-L})
		f
15	Z_{L-PE} or I_K	I_K or Z_{L-PE}
		R
		X_L
		U_{L-PE}
		f
16	R_E	R_H
		R_S
		δ
17	R_{ISO}	U_{ISO}
		[LIMIT !]
		[NOISE !]
or		
18	CABLE 3: $R_{ISO}(N-PE)$, $R_{ISO}(L1-PE)$, $R_{ISO}(L1-N)$,	U_{ISO} , [LIMIT !], [NOISE] U_{ISO} , [LIMIT !], [NOISE] U_{ISO} , [LIMIT !], [NOISE]
or		
19	CABLE 4: $R_{ISO}(L1-N)$, $R_{ISO}(L3-N)$, $R_{ISO}(L2-N)$,	U_{ISO} , [LIMIT !], [NOISE] U_{ISO} , [LIMIT !], [NOISE] U_{ISO} , [LIMIT !], [NOISE]
20	CABLE 4: $R_{ISO}(L1-L2)$, $R_{ISO}(L1-L3)$, $R_{ISO}(L2-L3)$,	U_{ISO} , [LIMIT !], [NOISE] U_{ISO} , [LIMIT !], [NOISE] U_{ISO} , [LIMIT !], [NOISE]

No.	Main result	Supplementary results
or		
21	CABLE 5: $R_{ISO}(N-PE)$, $R_{ISO}(L1-PE)$, $R_{ISO}(L1-N)$,	U_{ISO} , [LIMIT !], [NOISE] U_{ISO} , [LIMIT !], [NOISE] U_{ISO} , [LIMIT !], [NOISE]
22	CABLE 5: $R_{ISO}(L2-N)$, $R_{ISO}(L3-N)$, $R_{ISO}(L1-L2)$,	U_{ISO} , [LIMIT !], [NOISE] U_{ISO} , [LIMIT !], [NOISE] U_{ISO} , [LIMIT !], [NOISE]
23	CABLE 5: $R_{ISO}(L1-L3)$, $R_{ISO}(L2-L3)$, $R_{ISO}(L2-PE)$,	U_{ISO} , [LIMIT !], [NOISE] U_{ISO} , [LIMIT !], [NOISE] U_{ISO} , [LIMIT !], [NOISE]
24	CABLE 5: $R_{ISO}(L3-PE)$,	U_{ISO} , [LIMIT !], [NOISE]
25	$R \pm 200 \text{ mA}$	R_F
		R_R
		[NOISE !]

Remarks:

- During viewing the memory, empty measurements and memory banks are not accessible. "Measurement 1/20" signifies the first of the 20 measurements; measurements 21...99 are empty and inaccessible. The same principle applies to memory banks. If the memory is stored in a non-continuously, empty measurements and memory banks are omitted during viewing.

4.3 Deleting memory data

①

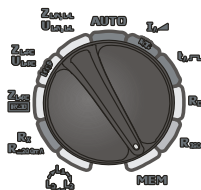

Set the rotary switch of function selection at **MEM** position.

②



Select "**Memory erasing**" by means of ▲ and ▼ push-buttons.



3



Press **ENTER** push-button.

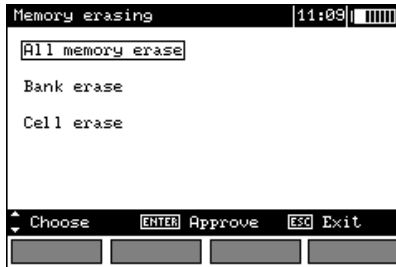

4



Select deletion of the whole memory, a memory bank or a measurement by means of ▲ and ▼ push-buttons.

5

Follow the instruction displayed by the meter.

5 Data transmission

Remarks:

- Data transmission is not possible during the charging of accumulators.
- Starting with firmware version 1.16, the support for data transmission via OR-1 module is disabled.

5.1 Computer connection accessories

What is necessary in order to operate the meter with a computer is additional accessories, namely a USB cable and appropriate software. If the required accessories such have not been purchased along with the meter, then they are available from the manufacturer or an authorised distributor.

The accessories may be used with many devices manufactured by SONEL S.A. equipped with the USB interface.

Detailed information regarding software is available at the manufacturer or an authorised distributor.

5.2 Data transmission with USB

1. Set the rotational function selector at MEM.
2. Plug the cable to the USB port of the computer and the USB socket of the meter.
3. Start the programme.

5.3 Data transmission with OR-1 radio module

1. Connect OR-1 module to the USB socket of the PC.
2. Start data filing programme.
3. Select **Wireless transmission** in the main MENU of the meter

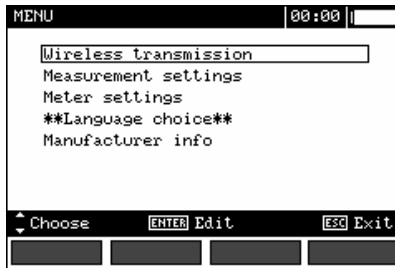

or set the function switch to **MEM** and press **F1**.



4. If a PIN code change is necessary, select **Modify PIN code**.



5. Set the required code with the cursors.

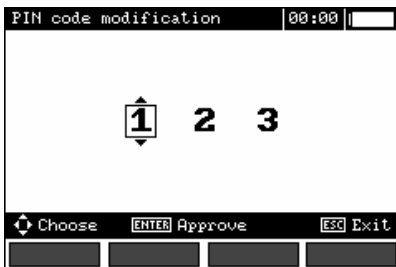

The same code must be entered in the computer programme. It is used for securing transmission.

6. To start transmission, select **Wireless transmission** in the MENU or press **F1** in the **MEM** position. The following messages will be displayed: **Connecting** and then **Connection active**. If it is impossible to establish connection the message **Wireless connection lost** will appear. Once the connection is established, follow the programme manual for data filing.

Note:



Standard pin for OR-1 is the „123”.

6 Power supply

6.1 Monitoring of the power supply voltage

The level of the charge of the batteries or accumulators is currently indicated by the symbol in the right upper corner of the display:



Bartery charged.



Bartery low.



Bartery fully discharged.

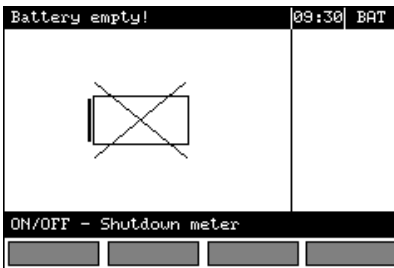

Bartery fully discharged,
measuring blocked.

Note:

- The displayed **BAT** symbol means insufficient power supply voltage and the need to charge the accumulators,
- Measurements realised with an insufficient meter power supply voltage are distorted with additional errors which are impossible to ascertain by the user and thus they cannot constitute a basis for a conclusion of correctness of the tested earthing system.

6.2 Replacement of batteries (accumulators)

MPI-525 meter is powered by 4 batteries (LR14). It can be also powered by the manufacturer's accumulator package (SONEL NiMH).

Battery charger is installed inside the meter and cooperates only with the manufacturer's accumulator package. The charger is powered by external power supply adapter. It can be also powered from the car cigarette lighter socket. The accumulator package as well as the power supply adapter are the additional accessories and can be purchase separately.

WARNING:

Test leads left in the sockets during replacement of the batteries or the package of accumulators cause a risk of electric shock with a dangerous voltage.

In order to replace the package of accumulators it is necessary to do the following:

- Remove all the test leads from the sockets and turn the meter off,
- Remove the four screws of the accumulators/batteries compartment (in the lower part of the casing),

- Replace the accumulators,
- Replace the four screws of the accumulators/batteries compartment.

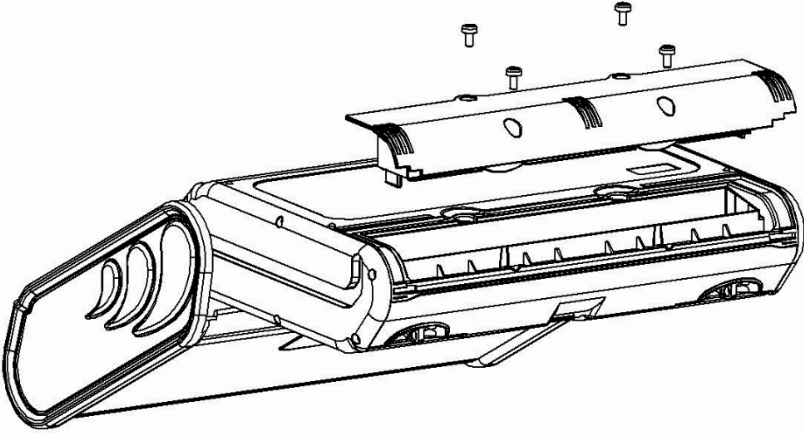

NOTE!

Do not use the meter when the accumulator compartment is removed or open nor power it from other sources than mentioned in this manual.

6.3 Charging of accumulators

Charging commences once the power supply has been connected to the meter regardless of the fact whether the meter is on or off. During charging the screen looks as it is presented in the following illustration. The accumulators are charged in accordance with the algorithm of „quick charge” – this process permits to reduce the duration of charging to approximately four hours. The end of the process of charging is signalled by: **Charging finished**. In order to turn the device off, remove the power supply plug of the charger.

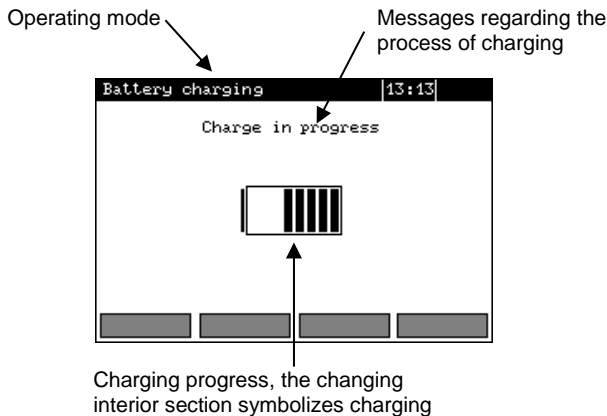

Note:

- As a result of interferences in the network it is possible that the process of charging of accumulators will finish too fast. In the case too short a time of charging is detected it is necessary to remove the plug of the charger and start charging anew.

Additional informations displayed by the meter

Message	Cause	Proceeding
Battery connection error!	Excessive voltage at the accumulator package during charging.	Check the contacts of the accumulator package. Should the problem persist, replace the package.
No battery!	No communication with the accumulator controller or batteries compartment put in.	Check the contacts of the accumulator package. Should the problem persist, replace the package. Put the accumulators compartment instead of batteries.
Battery temperature too low!	The ambient temperature is lower than 10°C	It is not possible to charge the accumulators correctly in such a temperature. Place the meter in a warm place and commence the charging mode anew. The present message may be displayed also in the case of deep discharging of the accumulators. It is then recommended to try to turn the charger repeatedly.
Precharge error	A damaged or deeply discharged accumulator package	The message is displayed for a while and then the precharge process begins again. If after several attempts the message: Battery temperature too high! is displayed, replace the package.

6.4 General principles regarding using Ni-MH accumulators

- If you do not use the device for a prolonged period of time, then it is recommended to remove the accumulators and store them separately.

- Store the accumulators in a dry, cool and well ventilated place and protect them from direct sunlight. The temperature of the environment in the case of prolonged storage should not exceed 30°C. If the accumulators are stored for a long time in a high temperature, then the occurring chemical processes may reduce their lifetime.

- Accumulators NiMH resist normally 500-1000 charging cycles. The accumulators reach their maximum capacity after being formatted (2-3 charge and discharge cycles). The most important factor which influences the lifetime of an accumulator is the depth of discharge. The deeper the discharge of the accumulator, the shorter its lifetime.

- The memory effect is limited in the case of NiMH accumulator. These accumulators may be charged at any point with no serious consequences. However, it is recommended to discharge them completely every few cycles.

- During storage of Ni-MH accumulators they are discharged at the rate of approximately 30% per month. Keeping accumulators at high temperatures may accelerate this process even 100%. In order to prevent excessive discharge of accumulators, after which it would be necessary to format them, it is recommended to charge the accumulators from time to time (even if not in use).

- Modern fast chargers detect both too low and too high a temperature of accumulators and react to the situation adequately. Too low a temperature should prevent the start of the process of charging, which might damage the accumulator irreparably. An increase of the temperature of the accumulator is a signal to stop charging and is a typical phenomenon. However charging at a high temperature of the environment apart from reducing the lifetime causes an accelerated increase of the temperature of the accumulator, which will be not charged to its full capacity.

- Remember that in the case of quick charging accumulators are charged to approximately 80% of their capacity; better results may be obtained if the process of charging is continued: the charger goes then to the phase of charging with a low current and after next couple of hours the accumulators are charged to their full capacity.

- Do not charge or use accumulators in extreme temperatures. Extreme temperatures reduce the lifetime of batteries and accumulators. Avoid placing devices powered from accumulators in very hot environments. The nominal working temperature must be absolutely observed.

7 Cleaning and maintenance

NOTE!

Apply solely the maintenance methods specified by the manufacturer within the present manual.

The casing of the meter may be cleaned with a soft, damp cloth using all-purpose detergents. Do not use any solvents or cleaning agents which might scratch the casing (powders, pastes, etc.).

Clean the probe with water and dry it. Before the probe is stored for a prolonged period of time it is recommended to grease it with any machine lubricant.

The reels and test leads should be cleaned with water and detergents, and then dried.

The electronic system of the meter does not require maintenance.

8 Storage

In the case of storage of the device, the following recommendations must be observed:

- Disconnect all the test leads from the meter.
- Clean the meter and all its accessories thoroughly.
- Wind the long test leads onto the reels.
- In the case the meter is to be stored for a prolonged period of time, the batteries must be removed from the device.
- In order to prevent a total discharge of the accumulators in the case of a prolonged storage, charge them from time to time.

9 Dismantling and utilisation

Worn-out electric and electronic equipment should be gathered selectively, i.e. it must not be placed with waste of another kind.

Worn-out electronic equipment should be sent to a collection point in accordance with the law of worn-out electric and electronic equipment.

Before the equipment is sent to a collection point, do not dismantle any elements.

Observe the local regulations concerning disposal of packages, worn-out batteries and accumulators.

10 Technical data

10.1 Basic data

⇒ abbreviation „w.m.” used in the specification of basic uncertainty signifies standard measured value

Measurement of alternating voltages (True RMS)

Range	Resolution	Basic uncertainty
0.0...299.9 V	0.1 V	±(2% w.m. + 6 digits)
300...500 V	1 V	±(2% w.m. + 2 digits)

- Frequency range: 45...65 Hz

Measurement of frequency

Range	Resolution	Basic uncertainty
45.0...65.0 Hz	0.1 Hz	±(0.1% w.m. + 1 digit)

- Voltage range: 50...500 V

Measurement of short circuit loop impedance Z_{L-PE} , Z_{L-N} , Z_{L-L}

Measurement of short circuit loop impedance Z_s

Test range according to IEC 61557:

Test lead	Test range Z_s
1.2 m	0.13...1999 Ω
5 m	0.17...1999 Ω
10 m	0.21...1999 Ω
20 m	0.29...1999 Ω
WS-03, WS-04	0.19...1999 Ω

Display range:

Display range	Resolution	Basic uncertainty
0...19.99 Ω	0.01 Ω	±(5% w.m. + 3 digits)
20.0...199.9 Ω	0.1 Ω	
200...1999 Ω	1 Ω	

- Nominal working voltage U_{N-L-N} / U_{N-L-L} : 110/190 V, 115/200 V, 127/220 V, 220/380 V, 230/400 V, 240/415 V
- Working range of voltage: 95...270 V (for Z_{L-PE} and Z_{L-N}) and 95...440 V (for Z_{L-L})
- Nominal network frequency f_n : 50 Hz, 60 Hz
- Working range of frequency: 45...65 Hz
- Maximum test current (for 415 V): 41.5 A (10 ms)
- Test of correct PE terminal connection with a touch electrode

Indications of short circuit loop resistance R_s and short circuit loop reactance X_s

Display range	Resolution	Basic uncertainty
0..19.99 Ω	0.01 Ω	±(5% + 5 digits) of Z_s value

- Calculated and displayed for a value of $Z_s < 20 \Omega$

Indications of short-circuit current I_k

Test ranges according to IEC 61557 can be calculated on the basis of test ranges for Z_S and nominal voltages.

Display range	Resolution	Basic uncertainty
0.055...1.999 A	0.001 A	Calculated on the basis of error for fault loop
2.00...19.99 A	0.01 A	
20.0...199.9 A	0.1 A	
200...1999 A	1 A	
2.00...19.99 kA	0.01 kA	
20.0...40.0 kA	0.1 kA	

- Prospective fault current calculated and displayed by the meter may slightly differ from the value calculated by the user with a calculator, basing on the displayed value of the impedance, because the meter calculates the current from unrounded value of fault loop impedance (which is used for displaying). As the correct value, consider I_k current value, displayed by the meter or by firmware.

Measurement of short circuit loop impedance Z_{L-PE} **RCD** (without tripping of RCD)

Measurement of short circuit loop impedance Z_S

Test range according to IEC 61557: 0.50...1999 Ω for 1.2 m, WS-03 and WS-04 leads and 0.51...1999 Ω for 5 m, 10 m and 20 m leads

Display range	Resolution	Basic uncertainty
0...19.99 Ω	0.01 Ω	$\pm(6\% \text{ w.m.} + 10 \text{ digits})$
20.0...199.9 Ω	0.1 Ω	$\pm(6\% \text{ w.m.} + 5 \text{ digits})$
200...1999 Ω	1 Ω	

- Do not trip RCD with $I_{\Delta n} \geq 30 \text{ mA}$
- Nominal working voltage U_n : 110 V, 115 V, 127 V, 220 V, 230 V, 240 V
- Working range of voltage: 95...270 V
- Nominal network frequency f_n : 50 Hz, 60 Hz
- Working range of frequency: 45...65 Hz
- Test of correct PE terminal connection with a touch electrode

Indications of short circuit loop resistance R_S and short circuit loop reactance X_S

Display range	Resolution	Basic uncertainty
0..19.99 Ω	0.01 Ω	$\pm(6\% + 10 \text{ digits})$ of Z_S value

- Calculated and displayed for a value of $Z_S < 20 \Omega$

Indications of short-circuit current I_k

Test range according to IEC 61557 can be calculated on the basis of test ranges for Z_S and nominal voltages.

Display range	Resolution	Basic uncertainty
0.055...1.999 A	0.001 A	Calculated on the basis of uncertainty for fault loop
2.00...19.99 A	0.01 A	
20.0...199.9 A	0.1 A	
200...1999 A	1 A	
2.00...19.99 kA	0.01 kA	
20.0...40.0 kA	0.1 kA	

- Prospective fault current calculated and displayed by the meter may slightly differ from the value calculated by the user with a calculator, basing on the displayed value of the impedance, because the meter calculates the current from unrounded value of fault loop impedance (which is used for displaying). As the correct value, consider I_k current value, displayed by the meter or by firmware.

Measurement of parameters of RCD

- Nominal working voltage U_n : 110 V, 115 V, 127 V, 220 V, 230 V, 240 V
- Working range of voltage: 95...270 V
- Nominal network frequency f_n : 50 Hz, 60 Hz
- Working range of frequency: 45...65 Hz

RCD trigger and trip time test t_A (for t_A mode).

Test range according to IEC 61557: 0 ms ... to the upper limit of displayed value

Type of RCD	Multiplication factor setting	Test range	Resolution	Basic uncertainty
Standard and short-time delay	0.5 $I_{\Delta n}$	0..300 ms	1 ms	$\pm 2\%$ w.m. ± 2 digits ¹⁾
	1 $I_{\Delta n}$			
	2 $I_{\Delta n}$	0..150 ms		
	5 $I_{\Delta n}$	0..40 ms		
Selective	0.5 $I_{\Delta n}$	0..500 ms		
	1 $I_{\Delta n}$			
	2 $I_{\Delta n}$	0..200 ms		
	5 $I_{\Delta n}$	0..150 ms		









¹⁾ for $I_{\Delta n} = 10$ mA and 0,5 $I_{\Delta n}$ uncertainty is $\pm 2\%$ w.m. ± 3 digits









- Accuracy of residual current setting:

for 1* $I_{\Delta n}$, 2* $I_{\Delta n}$ and 5* $I_{\Delta n}$ 0..8%

for 0,5* $I_{\Delta n}$ -8..0%

Effective value of sink current at measurement of RCD trip time

$I_{\Delta n}$	Multiplication factor setting							
	0.5				1			
								
10	5	3.5	3.5	5	10	20	20	20
30	15	10.5	10.5	15	30	42	42	60
100	50	35	35	50	100	140	140	200
300	150	105	105	150	300	420	420	600
500	250	175	175	—	500	700	700	1000*
1000	500	—	—	—	1000	—	—	—

$I_{\Delta n}$	Multiplication factor setting							
	2				5			
								
10	20	40	40	40	50	100	100	100
30	60	84	84	120	150	210	210	300
100	200	280	280	400	500	700	700	1000*
300	600	840	840	—	—	—	—	—
500	1000	—	—	—	—	—	—	—
1000	—	—	—	—	—	—	—	—

* - does not apply to $U_n = 110$ V, 115 V and 127 V

Measurement of resistance-to-earth R_E

Selected nominal current of RCD	Test range	Resolution	Test current	Basic uncertainty
10 mA	0.01 k Ω ...5.00 k Ω	0.01 k Ω	4 mA	0..+10% w.m. ± 8 digits
30 mA	0.01 k Ω ...1.66 k Ω		12 mA	0..+10% w.m. ± 5 digits
100 mA	1 Ω ..500 Ω	1 Ω	40 mA	0..+5% w.m. ± 5 digits
300 mA	1 Ω ..166 Ω		120 mA	
500 mA	1 Ω ..100 Ω		200 mA	
1000 mA	1 Ω ..50 Ω		400 mA	

Measurement of touch voltage U_B related to nominal residual current

Test range according to IEC 61557: 10.0...99.9 V

Test range	Resolution	Test current	Basic uncertainty
0..9.9 V	0.1 V	0.4 x $I_{\Delta n}$	0..10% w.m. ± 5 digits
10.0..99.9 V			0..15% w.m.

Measurement of RCD trip current I_A for sinusoidal residual current

Test range according to IEC 61557: (0.3...1.0) $I_{\Delta n}$

Selected nominal current of RCD	Test range	Resolution	Test current	Basic uncertainty
10 mA	3.0..10.0 mA	0.1 mA	0.3 x $I_{\Delta n}$..1.0 x $I_{\Delta n}$	$\pm 5\% I_{\Delta n}$
30 mA	9.0..30.0 mA			
100 mA	30..100 mA	1 mA		
300 mA	90..300 mA			
500 mA	150..500 mA			
1000 mA	300..1000 mA			

- it is possible to start the measurement from the positive or the negative half of residual current
- test current pass time max. 3200 ms

Measurement of RCD trip current I_A for residual unidirectional pulsed current and unidirectional pulsed current with 6mA direct current offset

Test range according to IEC 61557: (0.35...1.4) $I_{\Delta n}$ for $I_{\Delta n} \geq 30$ mA and (0.35...2) $I_{\Delta n}$ for $I_{\Delta n} = 10$ mA

Selected nominal current of RCD	Test range	Resolution	Test current	Basic uncertainty
10 mA	3.5..20.0 mA	0.1 mA	0.35 x $I_{\Delta n}$..2.0 x $I_{\Delta n}$	$\pm 10\% I_{\Delta n}$
30 mA	10.5..42.0 mA			
100 mA	35..140 mA	1 mA	0.35 x $I_{\Delta n}$..1.4 x $I_{\Delta n}$	$\pm 10\% I_{\Delta n}$
300 mA	105..420 mA			
500 mA	175..700 mA			

- measurement can be performed for positive or negative half-periods of residual current
- test current pass time max. 3200 ms

Measurement of RCD trip current I_A for residual direct current

Test range according to IEC 61557: $(0.2...2)I_{\Delta n}$

Selected nominal current of RCD	Test range	Resolution	Test current	Basic uncertainty
10 mA	2.0..20.0 mA	0.1 mA	$0.2 \times I_{\Delta n}..2.0 \times I_{\Delta n}$	$\pm 10 \% I_{\Delta n}$
30 mA	6..60 mA	1 mA		
100 mA	20..200 mA			
300 mA	60..600 mA			
500 mA	100..1000 mA			

- measurement can be performed for positive or negative residual current
- test current pass time max. 5040 ms

Measurement of resistance-to-earth R_E

Test range according to IEC 61557-5: 0.5 Ω ...1.99 k Ω for test voltage of 50 V and 0.56 Ω ...1.99 k Ω for test voltage of 25 V

Range	Resolution	Basic uncertainty
0.00...9.99 Ω	0.01 Ω	$\pm(2\% \text{ w.m.} + 4 \text{ digits})$
10.0...99.9 Ω	0.1 Ω	$\pm(2\% \text{ w.m.} + 3 \text{ digits})$
100...999 Ω	1 Ω	
1.00...1.99 k Ω	0.01 k Ω	

- test voltage: 25 V or 50 V rms
- test current: 20 mA, sinusoidal rms 125 Hz (for $f_n=50$ Hz) and 150 Hz (for $f_n=60$ Hz)
- blocking of measurement at interference voltage of $U_N>24$ V
- maximum measured voltage of interferences $U_{Nmax}=100$ V
- maximum resistance of auxiliary earth electrodes: 50 k Ω

Measurement of resistance of auxiliary earth electrodes R_H , R_S

Display range	Resolution	Basic uncertainty
000...999 Ω	1 Ω	$\pm(5\% (R_S + R_E + R_H) + 3 \text{ digits})$
1.00...9.99 k Ω	0.01 k Ω	
10.0...50.0 k Ω	0.1 k Ω	

Measurement of interference voltages

Internal resistance: about 100 k Ω

Range	Resolution	Basic uncertainty
0...100 V	1 V	$\pm(2\% \text{ w.m.} + 3 \text{ digits})$

Low-voltage measurement of continuity of circuit and resistance

Measurement of continuity of protective conductors and equipotential bondings with ± 200 mA current

Test range according to IEC 61557-4: 0,12...400 Ω

Range	Resolution	Basic uncertainty
0.00...19.99 Ω	0.01 Ω	$\pm(2\% \text{ w.m.} + 3 \text{ digits})$
20.0...199.9 Ω	0.1 Ω	
200...400 Ω	1 Ω	

- Voltage at open terminals: 4...9 V
- Output current at $R<2 \Omega$: min. 200 mA (I_{sc} : 200..250 mA)
- Compensation of test leads resistance
- Measurements for both polarizations of test current

Measurement of resistance with low current

Range	Resolution	Basic uncertainty
0.0...199.9 Ω	0.1 Ω	$\pm(3\% \text{ w.m.} + 3 \text{ digits})$
200...1999 Ω	1 Ω	

- Voltage at open terminals: 4...9 V
- Output current < 8 mA
- Audio signal for resistance being measured < 30 $\Omega \pm 50\%$
- Compensation of test leads resistance

Measurement of insulation resistance

Test range according to IEC 61557-2 for $U_N = 50 \text{ V}$: 50 k Ω ...250 M Ω

Display range for $U_N = 50 \text{ V}$	Resolution	Basic uncertainty
0...1999 k Ω	1 k Ω	$\pm (3 \% \text{ w.m.} + 8 \text{ digits})$
2.00...19.99 M Ω	0.01 M Ω	
20.0...199.9 M Ω	0.1 M Ω	
200...250 M Ω	1 M Ω	

Test range according to IEC 61557-2 for $U_N = 100 \text{ V}$: 100 k Ω ...500 M Ω

Display range for $U_N = 100 \text{ V}$	Resolution	Basic uncertainty
0...1999 k Ω	1 k Ω	$\pm (3 \% \text{ w.m.} + 8 \text{ digits})$
2.00...19.99 M Ω	0.01 M Ω	
20.0...199.9 M Ω	0.1 M Ω	
200...500 M Ω	1 M Ω	

Test range according to IEC 61557-2 for $U_N = 250 \text{ V}$: 250 k Ω ...999 M Ω

Display range for $U_N = 250 \text{ V}$	Resolution	Basic uncertainty
0...1999 k Ω	1 k Ω	$\pm (3 \% \text{ w.m.} + 8 \text{ digits})$
2.00...19.99 M Ω	0,01 M Ω	
20.0...199.9 M Ω	0,1 M Ω	
200...999 M Ω	1 M Ω	

Test range according to IEC 61557-2 for $U_N = 500 \text{ V}$: 500 k Ω ...2.00 G Ω

Display range for $U_N = 500 \text{ V}$	Resolution	Basic uncertainty
0...1999 k Ω	1 k Ω	$\pm (3 \% \text{ w.m.} + 8 \text{ digits})$
2.00...19.99 M Ω	0.01 M Ω	
20.0...199.9 M Ω	0.1 M Ω	
200...999 M Ω	1 M Ω	
1.00...2.00 G Ω	0.01 G Ω	$\pm (4 \% \text{ w.m.} + 6 \text{ digits})$

Test range according to IEC 61557-2 for $U_N = 1000 \text{ V}$: 1000 k Ω ...3,00 G Ω

Display range for $U_N = 1000 \text{ V}$	Resolution	Basic uncertainty
0...1999 k Ω	1 k Ω	$\pm (3 \% \text{ w.m.} + 8 \text{ digits})$
2.00...19.99 M Ω	0.01 M Ω	
20.0...199.9 M Ω	0.1 M Ω	
200...999 M Ω	1 M Ω	
1.00...3.00 G Ω	0.01 G Ω	$\pm (4 \% \text{ w.m.} + 6 \text{ digits})$

Test range according to IEC 61557-2 for $U_N = 2500 \text{ V}$: 2.50 M Ω ...9.99 G Ω

Display range for $U_N = 2500 \text{ V}$	Resolution	Basic uncertainty
0...1999 k Ω	1 k Ω	$\pm (3 \% \text{ w.m.} + 8 \text{ digits})$
2.00...19.99 M Ω	0.01 M Ω	
20.0...199.9 M Ω	0.1 M Ω	
200...999 M Ω	1 M Ω	
1.00...9.99 G Ω	0.01 G Ω	$\pm (4 \% \text{ w.m.} + 6 \text{ digits})$

- Test voltages: 50 V, 100 V, 250 V, 500 V, 1000 V and 2500V
- Accuracy of generated voltage ($R_{\text{load}} [\Omega] \geq 1000 \cdot U_N [\text{V}]$): -0+10% from the set value
- Detection of a dangerous voltage before commencing a measurement
- Discharging the object tested
- Insulation resistance measurement for multi-wire cables (max. 5) using an optional external adapter
- Measurement of voltage on terminals + R_{ISO} , - R_{ISO} within the range of: 0..440 V
- Test current < 2 mA

Phase sequence

- Phase sequence indicator: correct, incorrect
- Mains voltage range U_{L-L} : 95...500 V (45...65 Hz)
- Display of phase-to-phase voltages

Other technical data

- type of insulation..... double, EN 61010-1 and IEC 61557 compliant
- metrological category..... IV 300V (III 600V), EN 61010-1 compliant
- degree of housing protection acc. to EN 60529.....IP54
- power supply of the meter.....
 - alkaline batteries 4x1,5 V LR14 (C) or accumulator package SONEL NiMH 4,8 V 4,2 Ah
- parameters of AC adapter for the battery charge 100 V...240 V, 50 Hz...60 Hz
- dimensions 288 x 223 x 75 mm
- weight of the meter about 2,2 kg
- storage temperature -20...+70°C
- working temperature 0...+50°C
- temperature range suitable for initiating battery charging +10°C to +40°C
- temperatures at which loading is interrupted below +5°C and above (or equal to) +50°C
- humidity 20 %...90 %
- nominal temperature +23 \pm 2°C
- reference humidity 40 %...60 %
- altitude (above sea level) <2000 m
- time till automatic shutdown when idle (Auto-OFF) 5, 15, 30, 60 min or off
- number of measurements Z or RCD (for alkaline batteries) ... >3000 (2 measurements per minute)
- number of measurements R_{ISO} or R (for alkaline batteries) >2000
- display LCD, segment-type
- memory of measurement results 990 cells, 57,500 results
- data transmission USB and radio interface (waveband ISM 433 MHz)
- quality standard development, design and manufacturing are ISO 9001 compliant
- the device meets the requirements of IEC 61557 standard
- the product meets EMC requirements (immunity for industrial environment) according to the following standards EN 61326-1 and EN 61326-2-2

10.2 Additional data

Data on additional uncertainties are useful mainly when the meter is used in non-standard conditions and for metrological laboratories for the purpose of calibration.

10.2.1 Additional uncertainties according to IEC 61557-2 (R_{ISO})

Significant parameter	Designation	Additional uncertainty
Position	E ₁	0%
Supply voltage	E ₂	0% (BAT is not lit)
Temperature 0...35°C	E ₃	2%

10.2.2 Additional uncertainties according to IEC 61557-3 (Z)

Significant parameter	Designation	Additional uncertainty
Position	E ₁	0%
Supply voltage	E ₂	0% (BAT is not lit)
Temperature 0...35°C	E ₃	1,2 m lead – 0% 5 m lead – 0.011% 10 m lead – 0.019% 20 m lead – 0.035% WS-03, WS-04 lead – 0.015%
Phase angle 0..30° at the bottom of test range	E _{6,2}	0.6%
Frequency 99%..101%	E ₇	0%
Network voltage 85%..110%	E ₈	0%
Harmonic	E ₉	0%
DC component	E ₁₀	0%

10.2.3 Additional uncertainties according to IEC 61557-4 (R ±200 mA)

Significant parameter	Designation	Additional uncertainty
Position	E ₁	0%
Supply voltage	E ₂	0.5% (BAT is not lit)
Temperature 0...35°C	E ₃	1.5%

10.2.4 Additional uncertainties according to IEC 61557-5 (R_E)

Significant parameter	Designation	Additional uncertainty
Position	E ₁	0%
Supply voltage	E ₂	0% (BAT is not lit)
Temperature 0...35°C	E ₃	±0.25 digit/°C for 50 V ±0.33 digit/°C for 25 V
Serial interference voltage	E ₄	1%, generally according to the below formulas
Resistance of electrodes	E ₅	2% generally according to the below formulas and the diagram
Frequency 99%..101%	E ₇	0%
Network voltage 85%..110%	E ₈	0%

Additional uncertainty caused by serial interference voltage

R_E	Additional uncertainty [Ω]
0.00...9.99 Ω	$\pm((0.01R_E + 0.012)U_Z + 0.003 U_Z^2)$
10.0...99.9 Ω	$\pm((0.001R_E + 0.05)U_Z + 0.001 U_Z^2)$
100 Ω ...1.99 k Ω	$\pm((0.001R_E + 0.5)U_Z + 0.001 U_Z^2)$

Additional uncertainty caused by resistance of electrodes:

$\delta_{dod} = \pm \left(\frac{R_S}{100000 + R_S} \cdot 150 + \frac{R_H \cdot 0,004}{R_E} + 1,5 \cdot 10^{-8} \cdot R_H^2 \right)$ [%]	$R_S < 5 \text{ k}\Omega$
$\delta_{dod} = \pm \left(7,5 + \frac{R_H \cdot 0,004}{R_E} + 1,5 \cdot 10^{-8} \cdot R_H^2 \right)$ [%]	$R_S \geq 5 \text{ k}\Omega$

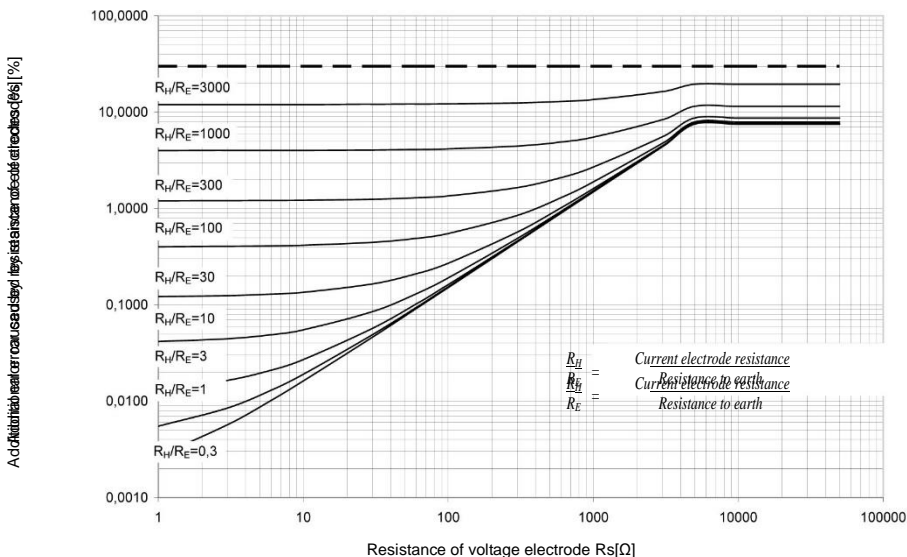

10.2.5 Additional uncertainties according to IEC 61557-6 (RCD)

I_A , t_A , U_B

Significant parameter	Designation	Additional uncertainty
Position	E_1	0%
Supply voltage	E_2	0% (BAT is not lit)
Temperature 0...35°C	E_3	0%
Resistance of electrodes	E_5	0%
Network voltage 85%..110%	E_8	0%

11 Accessories

The current list of accessories can be found on the manufacturer's website.

11.1 Standard accessories

Standard set of equipment supplied by the manufacturer includes:

- MPI-525 meter
- set of test leads:
 - Uni-Schuko lead with actuation of measurement for insulation resistance testing (cat. III 300V) – **WS-03 – WAADAWS03**
 - 1.2 m, cat III 1000V test leads with banana plugs – 3 leads (yellow – **WAPRZ1X2YEBB**, red – **WAPRZ1X2REBB** and blue - **WAPRZ1X2BUBB**)
 - 15 m-long test leads on reels (**WAPRZ015BUBBSZ** blue) and 30 m-long test lead (**WAPRZ030REBBSZ** red)
 - 1,8 m-long test leads 5kV for insulation measurement – 2 leads (red – **WAPRZ1X8REBB** and shielded black – **WAPRZ1X8LB**)
- accessories
 - cat. III 1000 V crocodile clip black – **WAKROBL20K01**
 - cat. III 1000 V crocodile clip yellow – **WAKROYE20K02**
 - 11 kV crocodile clip black – **WAKROBL32K09**
 - cat. III 1000 V test prod with banana socket – 3 test prods (yellow – **WASONYEOGB1**, red – **WASONREOGB1** and blue – **WASONBUOGB1**)
 - test prod 5kV red – **WASONREOGB2**
 - earth contact test probe (rod) 30 cm – 2 probes – **WASONG30**
- adapter for accumulator charging Z7 – **WAZASZ7**
- adapter cable (230 V) – **WAPRZLAD230**
- carrying case for the meters and accessories – **WAFUTL2**
- hanging straps for the meter (long – 1.5 m and short – 30 cm) – **WAPOZSZEKPL**
- USB interface cable – **WAPRZUSB**
- accumulator package NiMH 4.8V 4.2Ah – **WAAKU07**
- user manual
- calibration certificate

11.2 Optional accessories

Additionally, the following items that are not included in the scope of standard equipment can be purchased from the manufacturer or the distributors:

WAADAWS04



- test lead with angle plug (without triggering) – WS-04

WAPRZ050YEBBSZ



- test lead 50m long

WAADAAISO25



- adapter AutoISO-2500

WAPRZ025BUBBSZ



- test lead 25m long

WAPRZLAD12SAM



- cable for charging the accumulator package from the car cigarette lighter socket

WAADAAGT16P – five-wire version

WAADAAGT16C – four-wire version



- triple phase socket adapter AGT-16P

WAADAAGT32P – five-wire version
WAADAAGT32C – four-wire version



- triple phase socket adapter AGT-32P

WAADATWR1



- RCD testing adapter TWR-1

WASONG80



- earth contact test probe (rod) (80 cm)

WAADAAGT63P – five-wire version



- triple phase socket adapter AGT-63P

WAADAUSBOR1



- radio receiver OR-1 for data transmission (not supported by meters with firmware version 1.16 or later)

WAPOJ1



- batteries compartment
- calibration certificate with accreditation

Note

The software is supported by the following systems: Windows XP (Service Pack 2), Windows Vista, Windows 7.

12 Positions of the meter's cover

The movable cover enables using the meter in various positions.

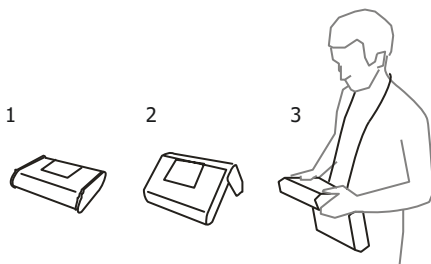

1 – Cover as the bottom of the meter

2 – Cover used as a support

3 – Cover in the position that enables convenient use of the meter suspended on the neck by means of hanging straps

13 Manufacturer

The manufacturer of the device, which also provides guarantee and post-guarantee service is the following company:

SONEL S.A.

Wokulskiego 11
58-100 Świdnica
Poland

tel. +48 74 858 38 60

fax +48 74 858 38 09

E-mail: export@sonel.pl

Web page: www.sonel.pl

Attention:

Service repairs must be realised solely by the manufacturer.

14 Laboratory services

SONEL Testing and Calibration Laboratory has been accredited by the Polish Center for Accreditation (PCA) - certificate no. AP 173.

Laboratory offers calibration for the following instruments that are used for measuring electrical and non-electrical parameters.



AP 173

• METERS FOR MEASUREMENTS OF ELECTRICAL PARAMETERS

- voltage meters,
- current meters (including clamp meters),
- resistance meters,
- insulation resistance meters,
- earth resistance and resistivity meters,
- RCD meters,
- short-circuit loop impedance meters,
- power quality analyzers,
- portable appliance testers (PAT),
- power meters,
- multimeters,
- multifunction meters covering the functions of the above-mentioned instruments,

• ELECTRICAL STANDARDS

- calibrators,
- resistance standards,

• METERS FOR MEASUREMENTS OF NON-ELECTRICAL PARAMETERS

- pyrometers,
- thermal imagers,
- luxmeters.

The **Calibration Certificate** is a document that presents a relation between the calibration standard of known accuracy and meter indications with associated measurement uncertainties. The calibration standards are normally traceable to the national standard held by the National Metrological Institute.

According to ILAC-G24 „Guidelines for determination of calibration intervals of measuring instruments”, SONEL S.A. recommends periodical metrological inspection of the instruments it manufactures no less frequently than once every **12 months**.

For new instruments provided with the Calibration Certificate or Validation Certificate at the factory, recalibration should be performed within **12 months** from the date of purchase, however, no later than **24 months** from the date of purchase.

ATTENTION !

The person performing the measurements should be absolutely sure about the efficiency of the device being used. Measurements made with an inefficient meter can contribute to an incorrect assessment of the effectiveness of health protection and even human life.





NOTES

WARNING AND GENERAL DATA DISPLAYED BY THE METER

WARNING!

The MPI-525 meter is designed for operation at rated phase voltages of 110V, 115V, 127V, 220V, 230V, and 240V as well as at phase-to-phase voltages of 190V, 200V, 220V, 380V, 400V, and 415V.

Any voltage that exceeds the admissible voltage must not be applied to any measuring terminals. Failure to observe this warning may result in damage to the device and cause danger to users.

L-N!	U_{L-N} voltage is incompatible with measuring procedure.
L-PE!	U_{L-PE} voltage is incompatible with measuring procedure.
N-PE!	U_{N-PE} voltage exceeds the admissible level of 50V.
	Phase connected to N terminal instead of L terminal.
	Exceeded temperature.
f!	Mains frequency exceeds the 45 ... 65Hz range.
Error during measure	Cannot display correct result.
Loop circuit malfunction	Send meter to service centre.
No U_{L-N}!	No U_{L-N} voltage prior to the main measurement.
Aborted!	Measurement has been stopped with ESC key.
$U > 500V!$ and continuous beep signal	Voltage on measuring terminals exceeds 500V prior to the measurement.
$U_N > 50V!$ and continuous beep signal	Voltage on measuring terminals exceeds 50V; measurement of R_E is locked.
$U_N!$	Voltage on measuring terminals exceeds 24V but does not reach 50V; measurement of R_E is locked.
LIMIT!	Uncertainty of R_E measurement from electrode resistance $> 30\%$.
	Discontinuity in R_E measuring circuit or probe resistance exceeds 60k Ω .
PE! and continuous beep signal	Voltage between touch electrode and PE exceeds the admissible U_L threshold value.
!	RCD failure if seen at the right-hand side of the result.
$U_B > U_L!$	Touch voltage U_B exceeds a preset U_L threshold value.
	Presence of measuring voltage on meter terminals at measurement of R_{ISO} .
NOISE!	Excessive signal interferences. Measurement may be distorted by additional variance.
LIMIT !!	Initiation of current constraints at measurements of R_{ISO} .
	Condition of batteries or accumulators: Batteries or accumulators are charged Batteries or accumulators are discharged Batteries or accumulators are out of use
BAT! (in the main field)	Batteries or accumulators are out of use. Install new batteries or charge the accumulators.



SONEL S.A.
Wokulskiego 11
58-100 Świdnica
Poland



+48 74 858 38 60
+48 74 858 38 00
fax +48 74 858 38 09

e-mail: export@sonel.pl
www.sonel.pl